

---

# PX1

Optical Power Expert



---

Copyright © 2019–2020 EXFO Inc. All rights reserved. No part of this publication may be reproduced, stored in a retrieval system or transmitted in any form, be it electronically, mechanically, or by any other means such as photocopying, recording or otherwise, without the prior written permission of EXFO Inc. (EXFO).

Information provided by EXFO is believed to be accurate and reliable. However, no responsibility is assumed by EXFO for its use nor for any infringements of patents or other rights of third parties that may result from its use. No license is granted by implication or otherwise under any patent rights of EXFO.

EXFO's Commerce And Government Entities (CAGE) code under the North Atlantic Treaty Organization (NATO) is 0L8C3.

The information contained in this publication is subject to change without notice.

### ***Trademarks***

EXFO's trademarks have been identified as such. However, the presence or absence of such identification does not affect the legal status of any trademark.

### ***Units of Measurement***

Units of measurement in this publication conform to SI standards and practices.

### ***Patents***

Feature(s) of this product is/are protected by one or more of: US patent 8,576,389 and equivalent patents pending and/or granted in other countries; US patent 9,170,173; US patent 9,571,186; US patent 10,014,935; and other pending utility and design patents.

Version number: 3.0.0.1

# Contents

Regulatory Information .....	v
<b>1 Introducing the PX1 Optical Power Expert .....</b>	<b>1</b>
Main Features .....	1
Available Options .....	3
LED Indicator Description .....	4
Battery Status Icon Description .....	5
Power Sources .....	6
Temperature Management .....	7
Technical Specifications .....	7
Conventions .....	8
<b>2 Safety Information .....</b>	<b>9</b>
General Safety Information .....	9
Other Safety Symbols on Your Unit .....	11
Laser Safety Information (Units with VFL) .....	12
Electrical Safety Information .....	13
<b>3 Setting up and Using Your PX1 .....</b>	<b>17</b>
Turning on Your Unit .....	17
Turning off Your Unit .....	18
Understanding the Main Window .....	19
Configuring the Auto-Off Value .....	20
Adjusting Brightness .....	22
Enabling or Disabling Sound Notifications on Your Unit .....	23
Adjusting the Date and Time .....	25
Changing the Power Units .....	27
Changing Wavelengths .....	29
Automatically Detecting Wavelengths (Pro Models) .....	31
Defining a List of Favorite Wavelengths (Pro Models) .....	33
Working With Pass/Fail Thresholds .....	38
Working in Min./Max. Mode .....	41
Nulling Electrical Offsets .....	42
Setting Reference Values on Your PX1 .....	44
Measuring Power or Loss .....	46
Switching Between Power and Loss Measurements .....	48
Using the VFL .....	49
Reverting to Factory Settings .....	51

# Contents

---

- 4 Managing Test Results ..... 55**
  - Viewing Measurements ..... 55
  - Viewing Results in the Margin Meter ..... 57
  - Deleting Measurements (Clearing Data) ..... 58
  
- 5 Working with the TestFlow Mobile Application ..... 63**
  - Installing the TestFlow Mobile Application on Your Smart Device ..... 64
  - Establishing or Closing a Connection With a Smart Device Via the Bluetooth Technology .... 65
  - Generating Measurement Reports ..... 69
  
- 6 Maintenance ..... 71**
  - Cleaning Detector Ports ..... 72
  - Cleaning VFL-Type Connectors ..... 73
  - Cleaning the Touchscreen ..... 74
  - Recharging the Battery ..... 74
  - Battery Maintenance Recommendations ..... 77
  - Replacing the Battery ..... 79
  - Upgrading the Application ..... 88
  - Recalibrating the Unit ..... 90
  - Recycling and Disposal ..... 91
  
- 7 Troubleshooting ..... 93**
  - Solving Common Problems ..... 93
  - Accessing the Online Documentation ..... 94
  - Contacting the Technical Support Group ..... 96
  - Viewing System Information ..... 97
  - Transportation ..... 99
  
- 8 Warranty ..... 101**
  - General Information ..... 101
  - Liability ..... 101
  - Exclusions ..... 102
  - Certification ..... 102
  - Service and Repairs ..... 103
  - EXFO Service Centers Worldwide ..... 104
  
- Index ..... 105**

## Regulatory Information

### **Canada and USA Electromagnetic Interference Regulatory Statement**

Electronic test and measurement equipment is exempt from FCC part 15, subpart B compliance in the United States of America and from ICES-003 compliance in Canada. However, EXFO Inc. makes reasonable efforts to ensure compliance to the applicable standards.

The limits set by these standards are designed to provide reasonable protection against harmful interference when the equipment is operated in a commercial environment. This equipment generates, uses, and can radiate radio frequency energy and, if not installed and used in accordance with the user documentation, may cause harmful interference to radio communications. Operation of this equipment in a residential area is likely to cause harmful interference in which case the user will be required to correct the interference at his own expense.

Modifications not expressly approved by the manufacturer could void the user's authority to operate the equipment.

### **European Electromagnetic Compatibility Regulatory Statement**

Warning: This is a class A product. In a domestic environment, this product may cause radio interference in which case the user may be required to take adequate measures. Your product is certified for (or is suitable for) use in industrial electromagnetic environments.

### **General Wireless Compliance Related Information**

Your unit comes with an internal wireless module (adapter) and antenna for which the information hereafter applies:

## Regulatory Information

---

This product does not contain any wireless user-serviceable components. Any unauthorized product changes or modifications will invalidate warranty and all applicable regulatory certifications and approvals.

### **Canada and USA Wireless Compliance Related Information**

Your unit comes with an internal wireless module (adapter) and antenna for which the information hereafter applies:

- This device complies with Part 15 of the FCC Rules.
- This device complies with Innovation, Sciences and Economic Development Canada license-exempt RSS standards.
- Operation is subject to the following two conditions:
  - (1) This device may not cause harmful interference
  - and
  - (2) this device must accept any interference received, including interference that may cause undesired operation.

#### ***Use in Specific Environments:***

- The use of wireless products in hazardous locations is limited by the constraints posed by the safety directors of such environments.
- The use of wireless products on airplanes is governed by the Federal Aviation Administration (FAA).
- The use of wireless products in hospitals is restricted to the limits set forth by each hospital.
- High-power radars are allocated as the primary users of the 5.25 to 5.35 GHz, and 5.65 to 5.85 GHz bands. These radar stations can cause interference with and/or damage to this device.

### ***Radiation Exposure Statement:***

- The product complies with the US/Canada portable RF exposure limit set forth for an uncontrolled environment and is safe for intended operation as described in this user documentation.
- Further RF exposure reduction can be achieved if the device can be kept as far as possible from the user's body.

### ***RF Function and Frequency Range:***

Your unit is designed to operate in the Bluetooth® 2.4 GHz bands, channels 0 through 80, 2400 MHz – 2480 MHz.

## **European Wireless Compliance Related Information**

Your unit is designed to operate in the Bluetooth® 2.4 GHz bands.

The information about the Bluetooth® bands is Channels 0 through 80 -2400 MHz - 2480 MHz.

The output power is 4 dBm typical.

This device is a 2.4 GHz wideband transmission system (transceiver), intended for use in all EU member states and EFTA countries, except in France and Italy where restrictive use applies.

In Italy, the end-user should apply for a license at the national spectrum authorities in order to obtain authorization to use the device for setting up outdoor radio links and/or for supplying access to telecommunications and/or network services.

This device may not be used for setting up radio links in France, and in some areas the RF output power may be limited to 10 mW EIRP in the frequency range of 2454 - 2483.5 MHz. For detailed information, the end-user should contact the national spectrum authority in France.

### European Declaration of Conformity

Hereby, EXFO declares that the radio equipment type “Wideband Data Transmission” is in compliance with European Directive 2014/53/EU.

The full text of the EU declaration of conformity is available at the following Internet address: [www.exfo.com/en/resources/legal-documentation](http://www.exfo.com/en/resources/legal-documentation).

### Japanese Technical Conformity Mark for Radio Law

This equipment contains specified radio equipment that has been certified to the Technical Regulation Conformity Certification for Japan, under the Radio Law.

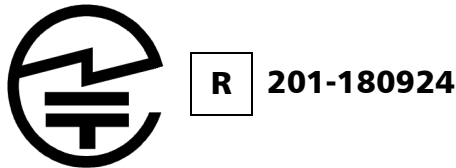

### Japan Wireless Compliance Related Information

Your unit is designed to operate in the Bluetooth<sup>®</sup> 2.4 GHz bands.

The information about the Bluetooth<sup>®</sup> bands is Channels 0 through 80, 2400 MHz – 2480 MHz.

The output power is 4 dBm typical.



# 1 **Introducing the PX1 Optical Power Expert**

The PX1 Optical Power Expert is an ultra-simple and ultra-fast tool that allows you to measure optical signal power or link loss values and store them at the touch of a button.

Pocket-sized and rugged, the PX1 is designed for extensive use in the field. It has a high capacity data storage for test results. When it comes to fiber tracing, the PX1 can detect four different tones emitted from a sources: 270 Hz, 330 Hz, 1 kHz and 2 kHz.

The unit comes with built-in expertise with automation that avoids human error (smart features such as auto-wavelength recognition and switching). The Pro configuration includes a visual fault locator that emits light in three different modes (continuous, slow blink and fast blink) to trace fibers and identify breaks and macrobends.

## **Main Features**

Your PX1 includes the following features:

- Color display
- Capacitive touchscreen
- Power and storage buttons for quick action
- Rechargeable battery
- Operates with USB power, even when charging battery and you can switch between the two modes without affecting operation
- Optional VFL
- Bluetooth® connectivity
- Easy software updates

# Introducing the PX1 Optical Power Expert

## Main Features

---

### Front panel

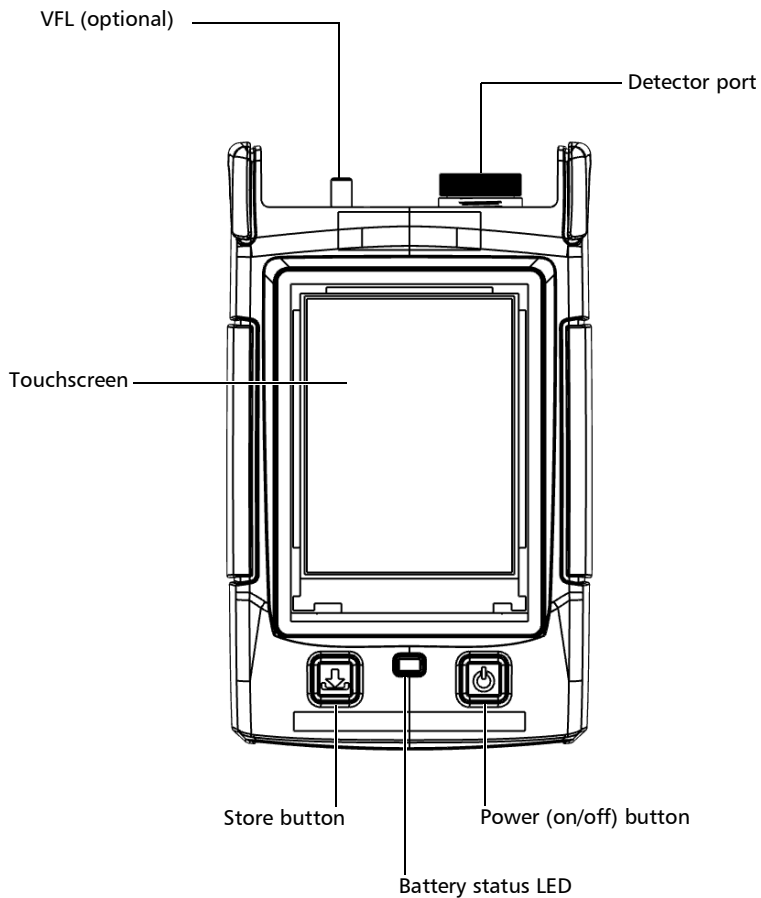

## Top panel

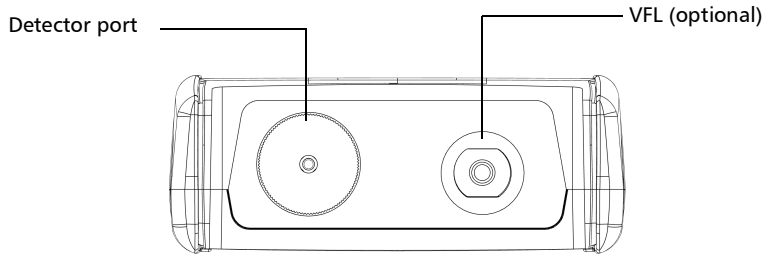

## Bottom panel

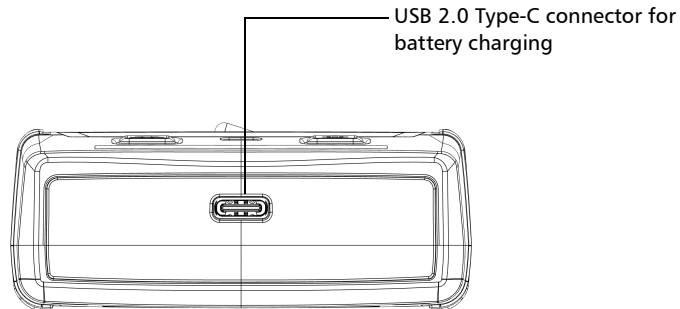

## Available Options

Several options are available for the Optical Power Expert:

Option	Description
PX1-S	Entry model (11 calibrated wavelengths) with standard range of 10 to -70 dBm.
PX1-H	Entry model (11 calibrated wavelengths) with high-power range of 26 to -50 dBm.
PX1-PRO-S	High end model (45 calibrated wavelengths) with VFL option and standard range of 10 to -70 dBm.
PX1 PRO-H	High end model (45 calibrated wavelengths) with VFL option with high-power range of 26 to -50 dBm.

## Introducing the PX1 Optical Power Expert

### *LED Indicator Description*

---



## LED Indicator Description

The LED indicator, located between the two buttons, provides you with information about the battery status.

Unit	Status	Meaning
Connected to an external power source	On	The battery is charging and the power level is equal to 95 % or more.
	Blinking – slow	The battery is charging and the power level is below 95 %.
	Blinking – fast	An error occurred. This could mean a charger error, that the temperature is too high, or that the battery power is too low.
Not connected to an external power source	Off	The unit is not charging and there are no errors.

### Battery Status Icon Description

The battery status icon is shown in the upper right corner of the title bar. It complements the information provided by the unit's LED.

Icon	Meaning
	The portion of the icon that appears in white in the title bar (in black here) reflects the current battery level.
	A red icon indicates that the battery level is running low and that you should connect the unit to a power outlet.
	A flash symbol indicates that the unit is charging.

## Introducing the PX1 Optical Power Expert

### Power Sources

---

## Power Sources

The Optical Power Expert operates with the following power sources:

- Indoor use only: USB power adapter connected to a power outlet (fastest way to charge the battery).

**Note:** *The standard USB ports of a computer can power your unit or charge its battery, but it will be slower than if you are using the adapter.*

**Note:** *If you have a vehicle equipped with dedicated USB charging ports, you could connect your unit to one of these ports to charge the battery. The actual results will vary with each vehicle. You could also use a certified USB power bank (portable charger) to charge your unit.*

- Indoor and outdoor use: One lithium-ion (Li-ion) or one lithium-polymer (Li-Po) rechargeable battery (main battery that automatically takes over if you disconnect the unit from its external power source). You can switch from an external power source to battery power or vice versa without affecting operation. The real-time clock is also powered by the battery; should the unit be fully discharged however, the real-time clock will retain the date and time values for a few days (typically a little over a week) until you recharge it again.

**Note:** *You can replace the main battery yourself (see Replacing the Battery on page 79), but this will reset the real-time clock.*

**Note:** *When the ambient temperature is below 0 °C (32 °F) or when it reaches or exceeds about 45 °C (113°F), the main battery can either charge more slowly than usual, or not charge at all, depending on the internal temperature of your unit.*

For more information, see *Electrical Safety Information* on page 13.

## Temperature Management

The internal temperature of your unit will vary with the ambient temperature. Your unit has been designed to adapt its behavior as necessary to regulate its temperature. For this reason, in high-temperature conditions, you could receive warning messages. If the temperature keeps rising and reaches the limit: your unit will turn off as self-protection.

For more information on the effects of temperature on battery charging, see *Power Sources* on page 6.



### IMPORTANT

For optimum performance of your unit:

- Ensure that it remains within the recommended operation and storage temperatures (see *Equipment Ratings* on page 14).
- Avoid leaving your unit in an overheated vehicle. You may have to let your unit cool down before being able to use it.
- Ensure that your unit is normally protected from direct sunlight (during use and storage).

## Technical Specifications

To obtain this product's technical specifications, visit the EXFO Web site at [www.exfo.com](http://www.exfo.com).

### Conventions

Before using the product described in this guide, you should understand the following conventions:



#### **WARNING**

Indicates a potentially hazardous situation which, if not avoided, could result in *death or serious injury*. Do not proceed unless you understand and meet the required conditions.



#### **CAUTION**

Indicates a potentially hazardous situation which, if not avoided, may result in *minor or moderate injury*. Do not proceed unless you understand and meet the required conditions.



#### **CAUTION**

Indicates a potentially hazardous situation which, if not avoided, may result in *component damage*. Do not proceed unless you understand and meet the required conditions.



#### **IMPORTANT**

Refers to information about this product you should not overlook.



## 2 **Safety Information**

### **General Safety Information**



#### **WARNING**

Do not install or terminate fibers while a light source is active. Never look directly into a live fiber and ensure that your eyes are protected at all times.



#### **WARNING**

The use of controls, adjustments and procedures, namely for operation and maintenance, other than those specified herein may result in hazardous radiation exposure or impair the protection provided by this unit.



#### **WARNING**

If the equipment is used in a manner not specified by the manufacturer, the protection provided by the equipment may be impaired.



#### **WARNING**

Use only accessories designed for your unit and approved by EXFO. For a complete list of accessories available for your unit, refer to its technical specifications or contact EXFO.

## Safety Information

### General Safety Information

---



### IMPORTANT

Refer to the documentation provided by the manufacturers of any accessories used with your EXFO product. It may contain environmental and/or operating conditions limiting their use.



### IMPORTANT

When you see the following symbol on your unit , make sure that you refer to the instructions provided in your user documentation. Ensure that you understand and meet the required conditions before using your product.



### IMPORTANT

When you see the following symbol on your unit , it indicates that the unit is equipped with a laser source, or that it can be used with instruments equipped with a laser source. These instruments include, but are not limited to, modules and external optical units.













### IMPORTANT

Other safety instructions relevant for your product are located throughout this documentation, depending on the action to perform. Make sure to read them carefully when they apply to your situation.

## Other Safety Symbols on Your Unit

One or more of the following symbols may also appear on your unit.

Symbol	Meaning
	Direct current
	Alternating current
	The unit is equipped with an earth (ground) terminal.
	The unit is equipped with a protective conductor terminal.
	The unit is equipped with a frame or chassis terminal.
	On (Power)
	Off (Power)
 OR 	On/off (Power)
	Fuse

## Safety Information

Laser Safety Information (Units with VFL)

### Laser Safety Information (Units with VFL)

Your instrument is in compliance with standard IEC 60825-1: 2014.

Laser radiation may be encountered at the optical output port.

The following label(s) indicate that the product contains a Class 2 source:

The following symbol means  
"DO NOT STARE INTO THE BEAM".



Located at the  
back of the unit

## Electrical Safety Information



### **WARNING**

If you need to ensure that the unit is completely turned off, disconnect the power cable and remove the battery. For more information on how to remove the battery, see the section about replacing the battery in this user documentation.



### **WARNING**

- Use the external power supply (USB power adapter) indoors only.
- Never connect the unit to the AC mains (with the USB power adapter) when it is used outdoors.
- To avoid electrical shock, do not operate the unit if any part of the outer surface (covers, panels, etc.) is damaged.
- Only authorized personnel should carry out adjustments, maintenance or repair of opened units under voltage. A person qualified in first aid must also be present. Do not replace any components while the USB cable and battery are connected.
- Unless otherwise specified, all interfaces are intended for connection to ES1 circuits only.
- Use only the listed and certified USB power adapter provided by EXFO with your unit. It provides reinforced insulation between primary and secondary, and is suitably rated for the country where the unit is sold.
- Capacitors inside the unit may be charged even if the unit has been disconnected from its electrical supply.

## Safety Information

### Electrical Safety Information



### CAUTION

- Position the unit so that the air can circulate freely around it.
- When you use the unit outdoors, ensure that it is protected from liquids, dust, direct sunlight, precipitation, and full wind pressure.



### CAUTION

The use of voltages higher than those indicated on the label affixed to your unit may damage the unit.

#### Equipment Ratings

Temperature	
➤ Operation	<ul style="list-style-type: none"><li>➤ unit powered by battery: <math>-10\text{ }^{\circ}\text{C}</math> to <math>50\text{ }^{\circ}\text{C}</math> (<math>14\text{ }^{\circ}\text{F}</math> to <math>122\text{ }^{\circ}\text{F}</math>)<sup>a</sup></li><li>➤ unit connected to AC power (with USB power adapter): <math>0\text{ }^{\circ}\text{C}</math> to <math>40\text{ }^{\circ}\text{C}</math> (<math>32\text{ }^{\circ}\text{F}</math> to <math>104\text{ }^{\circ}\text{F}</math>)<sup>b</sup></li></ul>
➤ Storage	<ul style="list-style-type: none"><li>➤ unit – short-term storage<sup>c</sup>: <math>-40\text{ }^{\circ}\text{C}</math> to <math>70\text{ }^{\circ}\text{C}</math> (<math>-40\text{ }^{\circ}\text{F}</math> to <math>158\text{ }^{\circ}\text{F}</math>)</li><li>➤ unit – long-term storage<sup>d</sup>: <math>10\text{ }^{\circ}\text{C}</math> to <math>45\text{ }^{\circ}\text{C}</math> (<math>50\text{ }^{\circ}\text{F}</math> to <math>113\text{ }^{\circ}\text{F}</math>)</li><li>➤ unit – recommended storage: <math>15\text{ }^{\circ}\text{C}</math> to <math>35\text{ }^{\circ}\text{C}</math> (<math>59\text{ }^{\circ}\text{F}</math> to <math>95\text{ }^{\circ}\text{F}</math>)</li></ul>
Relative humidity <sup>e</sup>	<ul style="list-style-type: none"><li>➤ unit: <math>\leq 93\%</math> non-condensing</li><li>➤ USB power adapter: <math>10\%</math> to <math>90\%</math> non-condensing</li></ul>
Maximum operation altitude	<ul style="list-style-type: none"><li>➤ <math>2000\text{ m}</math> (<math>6562\text{ ft}</math>) (unit connected to external power source)</li><li>➤ <math>5000\text{ m}</math> (<math>16405\text{ ft}</math>) (unit operated from battery)</li></ul>

<b>Equipment Ratings</b>	
Pollution degree	<ul style="list-style-type: none"> <li>➤ 2 (unit connected to external power source)</li> <li>➤ 3 (unit operated from battery)<sup>f</sup></li> </ul>
Overvoltage category	<ul style="list-style-type: none"> <li>➤ unit: I</li> <li>➤ USB power adapter: II</li> </ul>
Measurement category	Not rated for measurement categories II, III, or IV
Input power <sup>g</sup>	<ul style="list-style-type: none"> <li>➤ unit: 5 V ---; 2 A</li> <li>➤ USB power adapter: 100 - 240 V ~; 50/60 Hz; 1 A max</li> </ul>

- a. When the unit is used at an altitude of 5000 m, the maximum operating temperature is 45 °C (113 °F).
- b. When the ambient temperature is below 5 °C (41 °F) or when it reaches or exceeds about 45 °C (113°F), the main battery can either charge more slowly than usual, or not charge at all, depending on the internal temperature of your unit.
- c. Short-term storage corresponds to the storage of the unit for a maximum of 48 hours.
- d. Long-term storage corresponds to the storage of the unit for more than three months.
- e. Measured in 0 °C to 31 °C (32 °F to 87.8 °F) range, decreasing linearly to 50 % at 40 °C (104 °F).
- f. Equipment must be normally protected against exposure to direct sunlight, precipitation and full wind pressure.
- g. Not exceeding  $\pm 10\%$  of the nominal voltage.





# 3 **Setting up and Using Your PX1**

## **Turning on Your Unit**

When you turn on the unit for the very first time, a wizard is displayed, enabling you to read and accept the EXFO license agreement, then set the date and time, and then view where you can consult the user documentation.

### ***To turn on the unit:***

Press the on/off button until the unit beeps once.

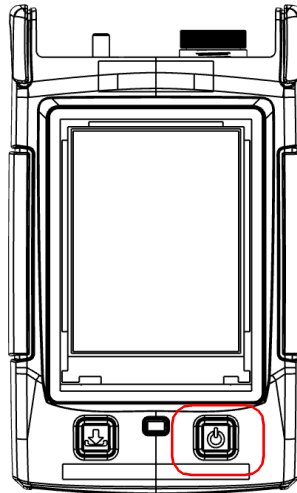

## Turning off Your Unit

Unless specified otherwise in this documentation, the settings you configure on your unit are kept in memory even when you turn the unit off.

### ***To turn off the unit:***

Press the on/off button. The unit will beep once.

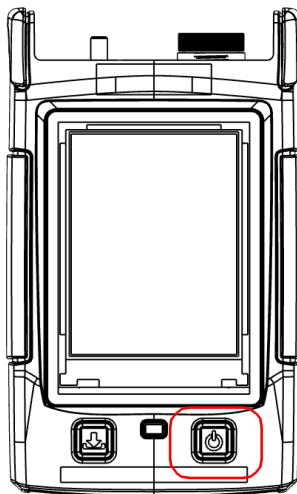

# Understanding the Main Window

The Optical Power Expert can be seen as the starting point of the application. You can perform measurements and navigate through the results.

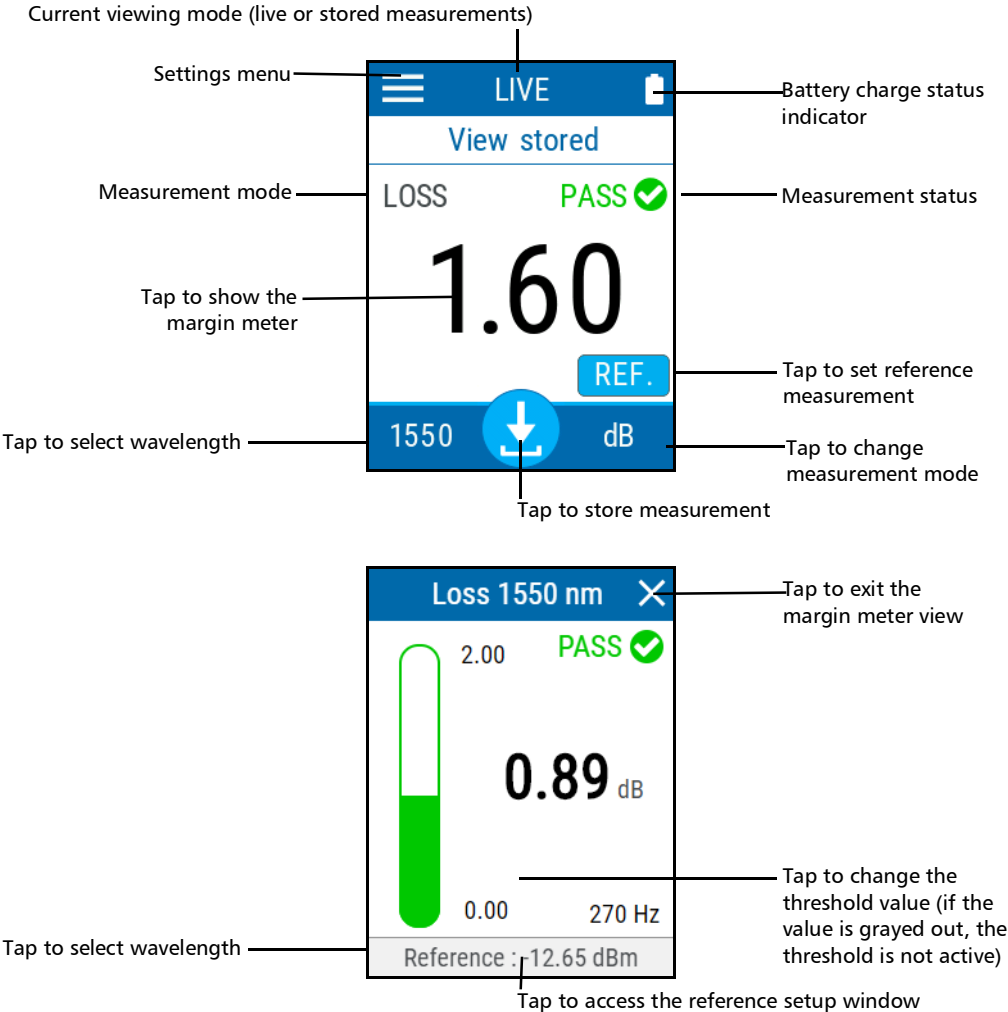



## Configuring the Auto-Off Value

To help you get the optimum performance out of your unit, it comes with a predefined set of parameters to manage power. When you do not use your unit for a while, it will shut down automatically to save power.

By default, the duration after which the unit goes into sleep mode is two minutes, but you can select another value. The value that you set is kept in memory even when you turn the unit off.

### **To configure the auto-off value:**

1. From the main PX1 page, tap the  icon to access the menu, then select .
2. Under **Unit settings**, tap **Auto off**.

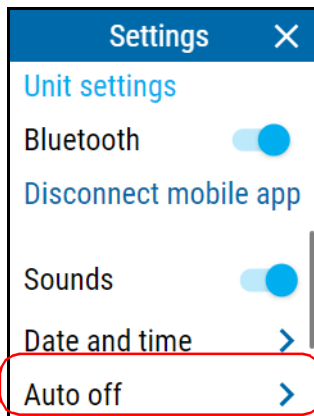

3. Select the desired number of minutes.

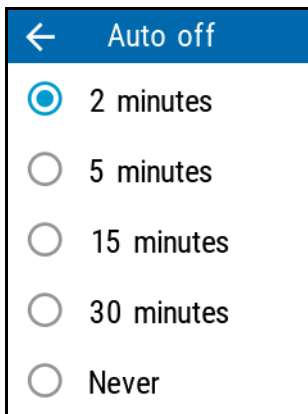

The screenshot shows a settings menu titled "Auto off" with a back arrow on the left. Below the title are five radio button options: "2 minutes" (selected), "5 minutes", "15 minutes", "30 minutes", and "Never".

The new value is taken into account immediately.



## Adjusting Brightness

You may want to adjust the display brightness yourself to better fit your work environment or preferences.

You may also want to reduce the display brightness to save battery power (the higher the brightness level, the higher the power consumption).

The brightness value is kept in memory even when you turn the unit off.

### **To adjust the display brightness:**

1. From the main PX1 page, tap the  icon to access the menu, then select .
2. Under **Brightness**, tap the dots until the screen appearance is to your liking. You can also tap the desired brightness icon to quickly set the brightness to the minimum or the maximum value.

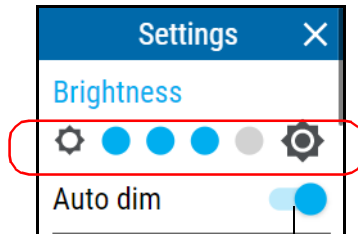

The screen will dim automatically after a while if there is no activity on the unit.

The new brightness value is taken into account immediately.

## Enabling or Disabling Sound Notifications on Your Unit

By default, your unit emits a sound when certain events occur. You can choose to disable some of them if you prefer. This preference will be kept in memory even when you turn the unit off.

The table below shows which notifications can be disabled.



<b>Notifications that can be disabled</b>	<b>Notifications that cannot be disabled</b>
<ul style="list-style-type: none"><li>➤ Modulation detection</li><li>➤ Bluetooth is connected or disconnected</li><li>➤ Measurement is being stored</li><li>➤ Auto-wavelength/switching detection</li></ul>	<ul style="list-style-type: none"><li>➤ Unit is turned On/Off</li><li>➤ External power supply connected or disconnected.</li><li>➤ High power detected (over 24 dBm)</li></ul>

## Setting up and Using Your PX1

### *Enabling or Disabling Sound Notifications on Your Unit*

---

#### **To enable or disable the sound notifications on your unit:**

1. From the main PX1 page, tap the  icon to access the menu, then select .
2. With the **Sounds** toggle, enable or disable the sound notifications.

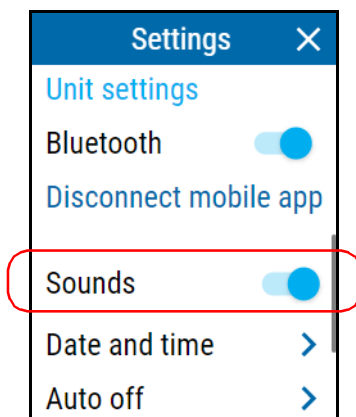

The new value is taken into account immediately.



## Adjusting the Date and Time

The time is displayed in the title bar. When saving results, the unit also saves the corresponding date and time.



**Note:** Time is expressed in a 24-hour format.

**Note:** The date is displayed in the international standard date notation (yyyy mm dd).

You can set the date and time manually or let the unit synchronize them automatically with the TestFlow mobile application (not available when unit is used without a smart device).

If you use your unit in conjunction with a smart device, each time a connection is established between the two, by default, the date, time and time zone of the unit are synchronized with those of the smart device.

### To adjust the date and time:

1. From the main PX1 page, tap the  icon to access the menu, then select .
2. Under **Unit settings**, tap **Date and time**.

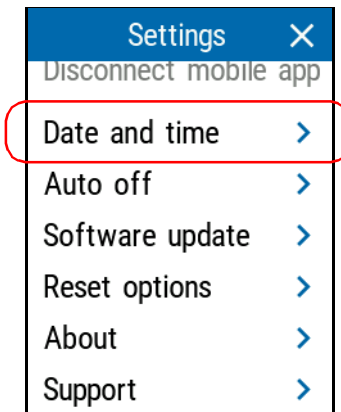

## Setting up and Using Your PX1

### *Adjusting the Date and Time*

---

3. Tap the element corresponding to the value that you want to modify.

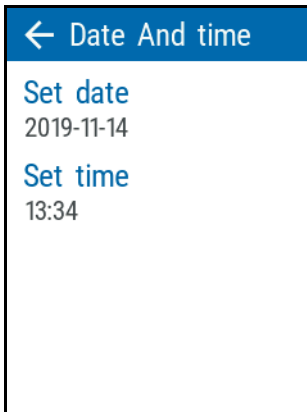

4. Using the arrow buttons, modify the settings according to your needs, and then tap **OK** to confirm.

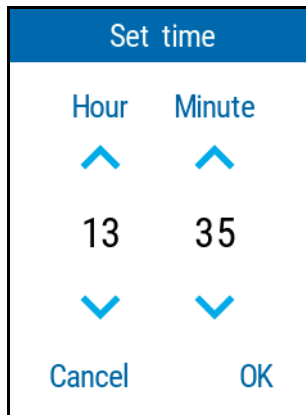
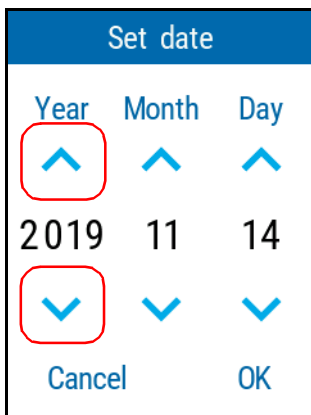



The new values are taken into account immediately.

# Changing the Power Units

You can work with your PX1 using either dBms or watts.

### **To change the power units:**

1. From the main PX1 page, tap the  icon to access the menu, then select .
2. Under **Power Meter**, tap **Power units**.

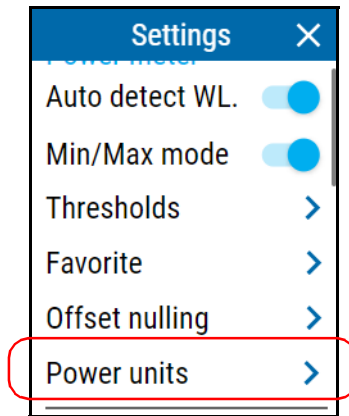

## Setting up and Using Your PX1

### *Changing the Power Units*

---

3. Select the desired units, dBm or watts.

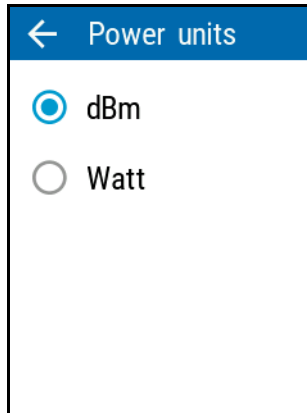

The changes are effective immediately.

## Changing Wavelengths

A list of wavelengths is available for you to perform your tests.

**To select the wavelength you want to use:**

1. From the main PX1 page, tap the wavelength at the bottom left side to open the selection menu.

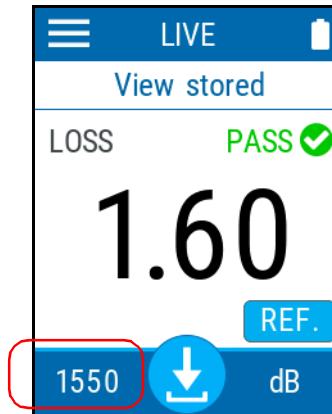

## Setting up and Using Your PX1

### Changing Wavelengths

---

2. Select the desired value in the list. Scroll up or down by dragging your finger on the screen to see more available values.

If you select **Auto** the wavelength will automatically change to match the one used by a compatible light source when connected.

**Note:** *If you have a Pro model, you will also have access to the CWDM and downstream PON wavelengths. Use the arrow buttons at the top of the window to access the corresponding list.*

**Note:** *This is independent from the Auto-detect mode (see Automatically Detecting Wavelengths (Pro Models) on page 31) and overrides that setting even if it is set to off.*

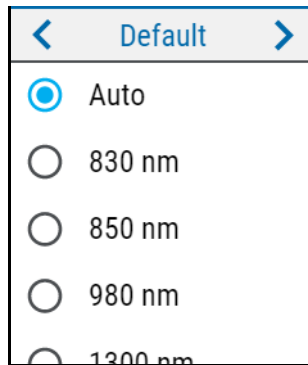

After selecting the value, you automatically return to the main page.

## Automatically Detecting Wavelengths (Pro Models)

Compatible sources can transmit their wavelength value through the fiber, avoiding the need to manually match the source and power meter wavelengths.

You can choose for the PX1 to automatically detect the wavelength sent by the source. Enabling this option signifies that the test unit is always verifying if the wavelength is included in the incoming signal.

This means, however, that when the automatic detection option is active and that your unit receives a signal or when the source is in auto-switching mode, you cannot manually change the power meter wavelength. The power meter behavior is totally determined by the source.

**Note:** *The auto detection option is activated by default.*

When the automatic detection is not active, you can still select the auto wavelength parameters; this mean that user has control to select a specific wavelength even if PX1 receive an auto-wavelength or auto-switching signal.

## Setting up and Using Your PX1

### *Automatically Detecting Wavelengths (Pro Models)*

---

#### **To receive the auto-wavelength signal or detect the source's auto-switching mode:**

1. From the main PX1 page, tap the  icon to access the menu, then select .
2. Under **Power Meter**, tap **Auto detect WL.**

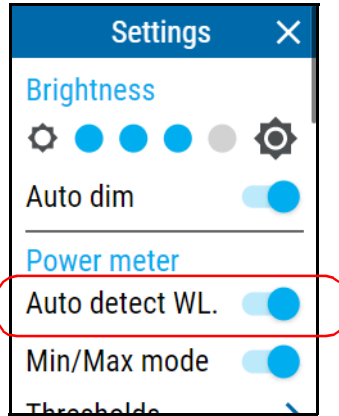

3. Connect a compatible source to your power meter.
4. Activate the source in auto mode (refer to the user documentation of the source for more information) or in auto-switching mode.

Your power meter automatically matches the source wavelength. If the wavelengths differ, it also beeps and returns you to normal operating mode.



## Defining a List of Favorite Wavelengths (Pro Models)

La liste "Favorite" est vide après "Reverting to Factory Settings". La liste "Default" a les 45 wavelengths avec un modèle PRO et 11 avec un modèle Standard.

You must put the wavelengths you want to use on a list of favorite wavelengths. Only wavelengths on this list are available for measurements. You may enter up to 24 favorite wavelengths.

At the factory (or after recalibration), the default list contains 11 calibrated wavelengths in the case of standard units, and 45 calibrated wavelengths and one ITU channel set for the Pro units. The favorite list is empty.

You can obtain the highest accuracy using the calibrated wavelengths. For other wavelengths, the unit will determine values based on the calibrated wavelengths (3-point interpolation).



<b>Default Wavelengths Standard Unit (nm)</b>	<b>Default Wavelengths Pro Unit (nm)</b>
830, 850, 980, 1300, 1310, 1450, 1490, 1550, 1577, 1590, 1650.	800, 820, 830, 840, 850, 860, 870, 880, 910, 980, 1270, 1280, 1290, 1300, 1310, 1320, 1330, 1340, 1350, 1370, 1390, 1410, 1430, 1450, 1460, 1470, 1480, 1490, 1500, 1510, 1520, 1530, 1540, 1550, 1560, 1570, 1577, 1580, 1590, 1600, 1610, 1620, 1630, 1640, 1650.

## Setting up and Using Your PX1

### Defining a List of Favorite Wavelengths (Pro Models)

---

#### To add wavelengths to the list:

1. From the main PX1 page, tap the  icon to access the menu, then select .
2. Under **Power Meter**, tap **Favorite**.

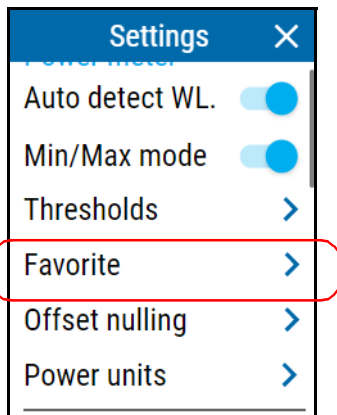

3. Tap on **Add**.

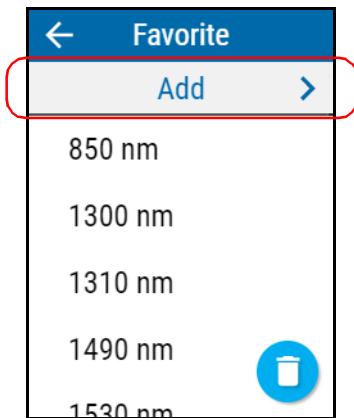

## Setting up and Using Your PX1

### *Defining a List of Favorite Wavelengths (Pro Models)*

---

4. Enter a new value using the arrow buttons.

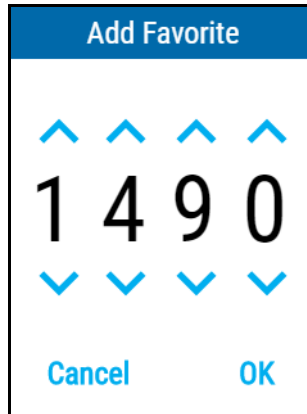

5. Tap **OK** to confirm the new wavelength and return to the list of favorites.
6. Repeat steps 3 to 5 for each new wavelength you want to add.

## Setting up and Using Your PX1

### Defining a List of Favorite Wavelengths (Pro Models)

---

#### To delete wavelengths from the list:

1. From the main PX1 page, tap the  icon to access the menu, then select .
2. Under **Power Meter**, tap **Favorite**.

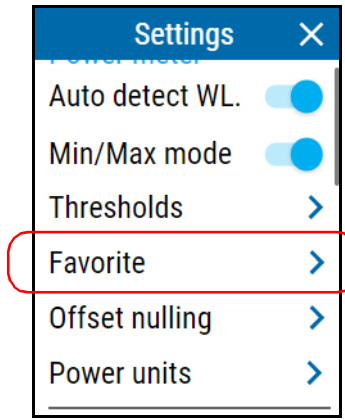

3. Tap on the corresponding button.

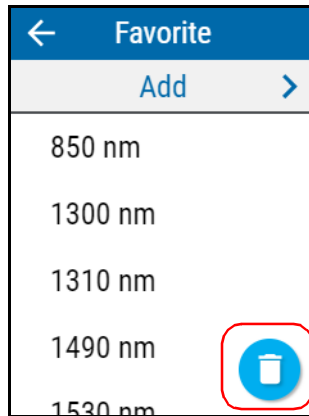

**Note:** To delete a single wavelength, you can press and hold the corresponding wavelength in the list for two seconds, then confirm your choice.

## Setting up and Using Your PX1

### *Defining a List of Favorite Wavelengths (Pro Models)*

---

4. Select which wavelength or wavelengths you want to remove, then tap **Remove**.

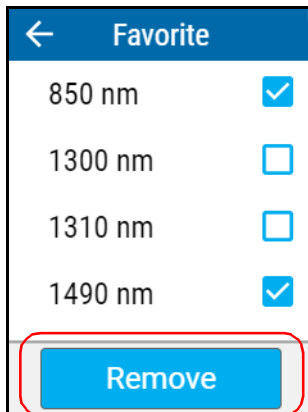

## Setting up and Using Your PX1

### Working With Pass/Fail Thresholds

---

## Working With Pass/Fail Thresholds

As soon as a measurement is complete, the application displays a pass or fail status when thresholds are applied.

### To configure thresholds

1. From the main PX1 page, tap the  icon to access the menu, then select .
2. Under **Power Meter**, tap **Thresholds**.

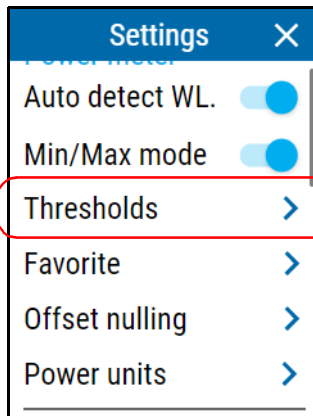

3. Select whether the threshold values will be valid for all wavelengths, if each wavelength will have specific thresholds or if no thresholds will be used for the measurements.

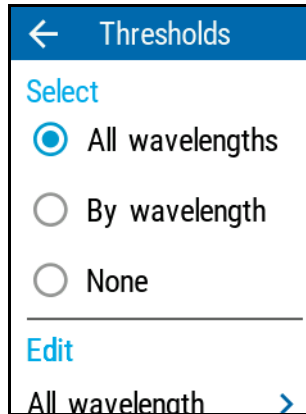

4. Depending on the option you have selected, select the corresponding menu.

**Note:** If you select **By wavelength**, select the desired wavelength or channel as well.

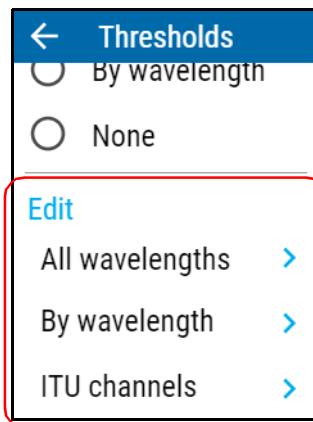

## Setting up and Using Your PX1

### Working With Pass/Fail Thresholds

---

5. You can enable or disable the thresholds using the corresponding sliders. If you want to change the value, tap on the threshold you want to modify.

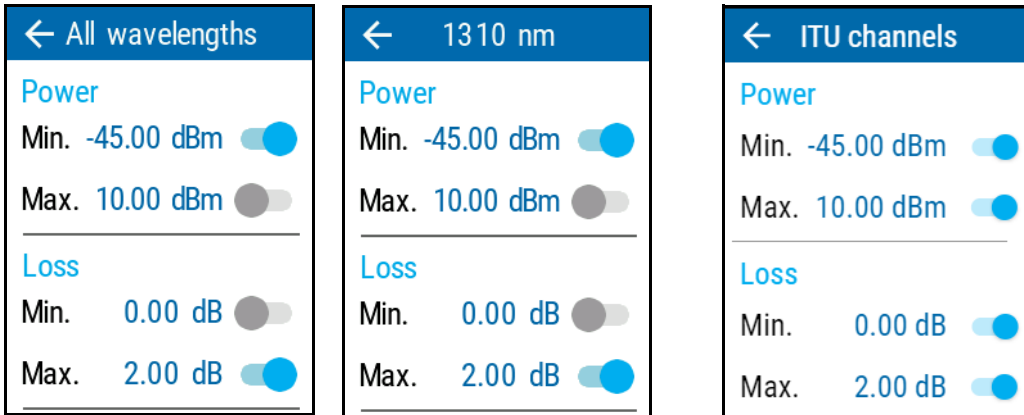

6. Enter a new value using the arrow buttons.

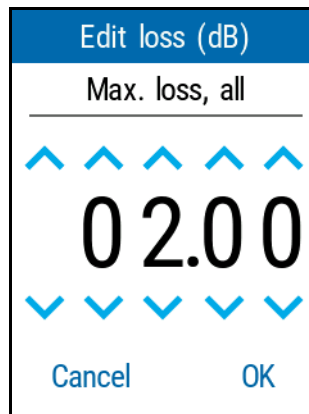

7. Tap **OK** to return to the page you were beforehand. The new thresholds are taken into account for the next measurement.



### Working in Min./Max. Mode

With the Hold Min/Max mode you can record extreme values of a varying power signal. You could use it to test the stability of a light source over time. In this mode, the unit displays the minimum or maximum power value read up to now. It continuously updates the display if a new min/max is measured.

**To enable the min./max. mode:**

1. From the main PX1 page, tap the  icon to access the menu, then select .
2. Under **Power Meter**, tap **Min./Max mode**.

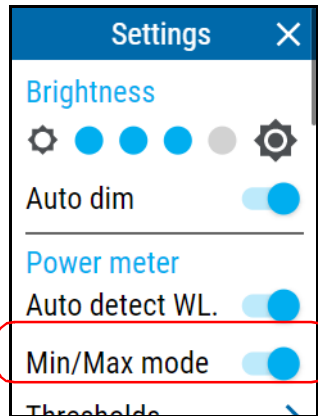

## Setting up and Using Your PX1

### Nulling Electrical Offsets

---

The minimum and maximum values will be indicated on screen when you return to the main window.

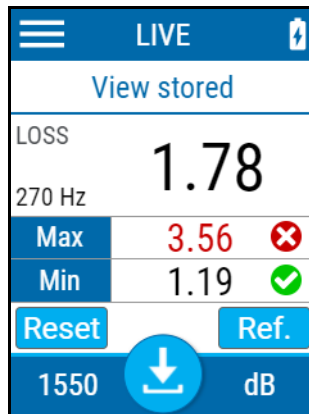

## Nulling Electrical Offsets



Temperature and humidity variations affect the performance of electronic circuits and optical detectors. Nulling the electrical offsets eliminates these effects.



### IMPORTANT

If light reaches the detector when nulling offsets, you will be notified and the nulling is not performed. You can retry after putting a cap on the detector.

#### ***To perform an offset nulling:***

1. If you have not done so already, put a cap on the detector.
2. From the main PX1 page, tap the  icon to access the menu, then select .

3. Under **Power Meter**, tap **Offset nulling**.

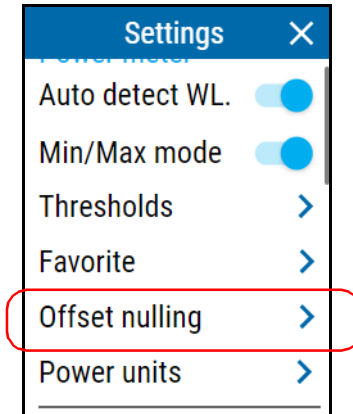

4. Tap **Nulling** and wait for the operation to complete. Once it is done, tap **OK** to return to the **Settings** page.

## Setting up and Using Your PX1

*Setting Reference Values on Your PX1*

---

### Setting Reference Values on Your PX1

In loss measurement mode, your unit displays on screen the loss created by the fiber under test, since it subtracts a reference value from the measured power.

You can set a different reference value for each wavelength. The reference value are kept in memory until you select new ones.

**To set reference values:**

1. Inspect your fibers and clean them properly.
2. Using the proper adapter and test jumpers, connect a light source to your unit.
3. Select the wavelength for which you want to take a reference, as explained in *Changing Wavelengths* on page 29.
4. From the main window, tap **REF.**

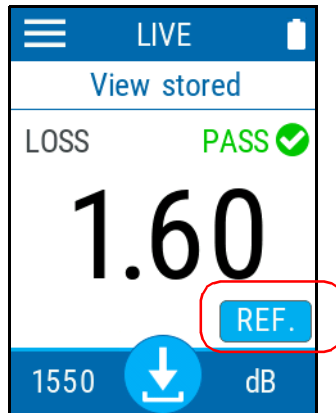

5. You can set the reference in two different ways:
  - Tap in the Ref. section to change the value as needed.OR
  - Measure the power of the source as the reference and tap **Take reference** to use the resulting measurement.

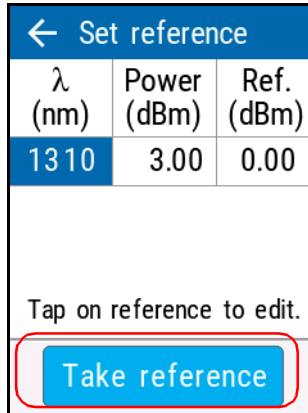

← Set reference		
$\lambda$ (nm)	Power (dBm)	Ref. (dBm)
1310	3.00	0.00
Tap on reference to edit.		
<b>Take reference</b>		

You are returned to the main window automatically and the reference is effective immediately.

6. Select another wavelength and repeat the process to set another reference.

## Measuring Power or Loss

Measuring absolute power or link loss is done the same way, except for the referencing step.

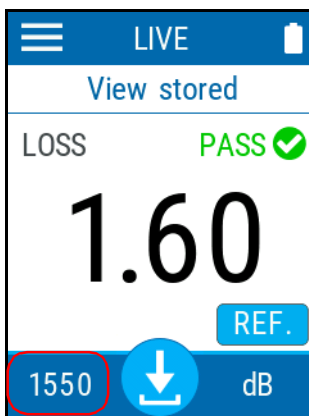

### **To perform power measurements:**

1. Inspect your fibers and clean them properly.
2. Connect the fiber to the connector port.
3. Select a wavelength and activate the source at the same wavelength.

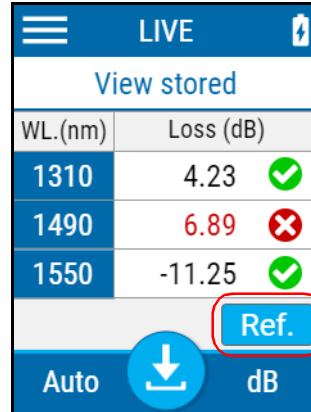
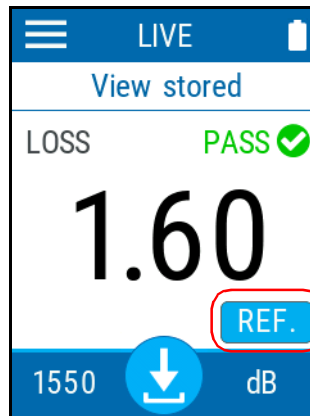

4. If you have not done so already, take a reference for the wavelength as explained in *Setting Reference Values on Your PX1* on page 44.



5. Tap  or press the  button to store the measurement.
6. Repeat the procedure for other wavelengths.

## Switching Between Power and Loss Measurements

You can switch between the power and loss measurement mode of the unit directly on the main page. The power units you have selected in *Changing the Power Units* on page 27 will apply accordingly when you change the mode.

### **To change the measurement mode:**

From the main PX1 page, tap the mode at the bottom right side to switch modes.

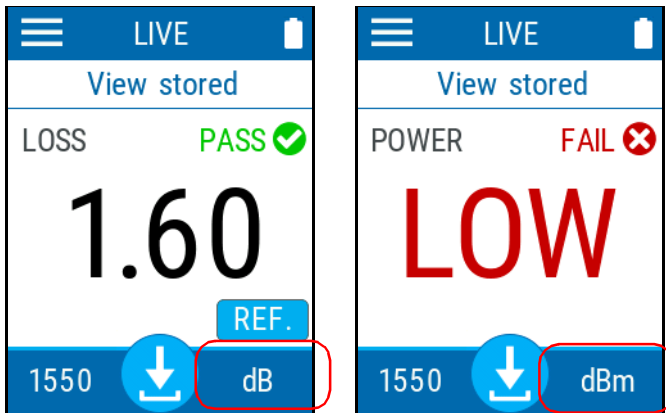



## Using the VFL

Your unit may be equipped with a VFL that you can set to the following modes:

- Continuous
- Slow blink
- Fast blink.



### WARNING

Do not install or terminate fibers while a light source is active. Never look directly into a live fiber and ensure that your eyes are protected at all times.

**To activate the VFL:**

1. From the main PX1 page, tap the  icon to access the menu, then select .
2. Select the desired mode for the signal from the available choices.

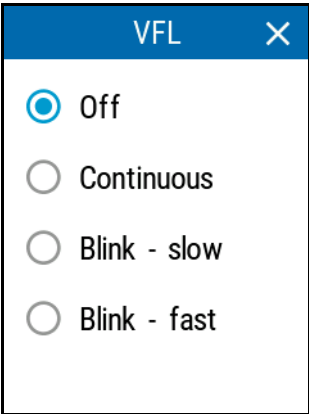

## Setting up and Using Your PX1

### Using the VFL

---

3. Tap  to exit the page and return to the main window. The active VFL icon will appear at the top to indicate that it is emitting.



**Note:** *The icon can also be used to access the VFL menu.*

#### **To deactivate the VFL:**

1. From the main PX1 page, tap the  icon to access the menu, then select .
2. Select **Off**.

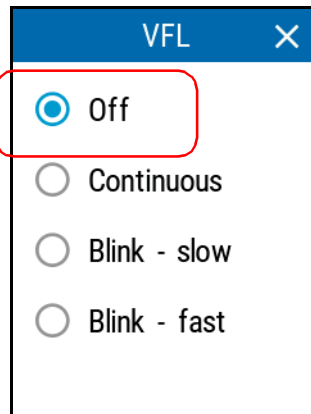



3. Tap  to exit the page and return to the main window.

### Reverting to Factory Settings

At any time, you can use one of these options, according to your needs:

- reset all settings of the unit that you have customized, such as the thresholds, to their default values
- reset the PX1 to factory settings

**To revert values to factory settings:**

1. From the main PX1 page, tap the  icon to access the menu, then select .
2. Scroll down to the **Unit settings** section.
3. Tap **Reset options**.

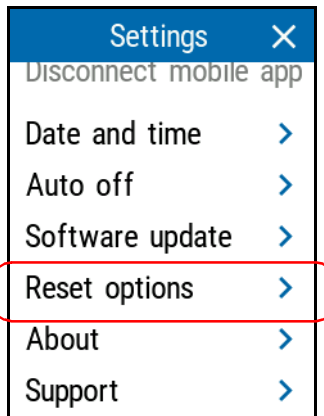

## Setting up and Using Your PX1

### Reverting to Factory Settings

---

4. Select the desired option.

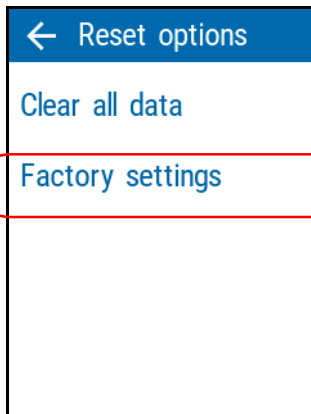

5. Tap **OK** to confirm your choice.

#### **To reset threshold settings:**

1. From the main PX1 page, tap the  icon to access the menu, then select .
2. Under **Power Meter**, tap **Thresholds**.

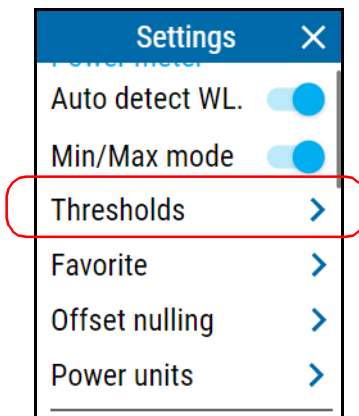

3. Select the category for which you want to reset the thresholds.

**Note:** If you select the **By wavelength** menu, select the desired wavelength as well.

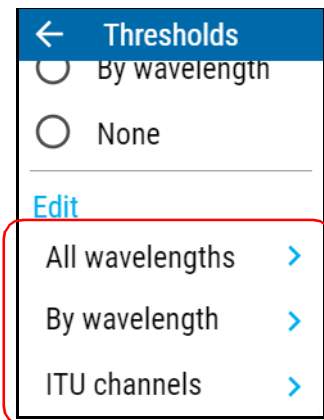

4. Scroll down to the bottom of the page and tap **Reset to defaults**.

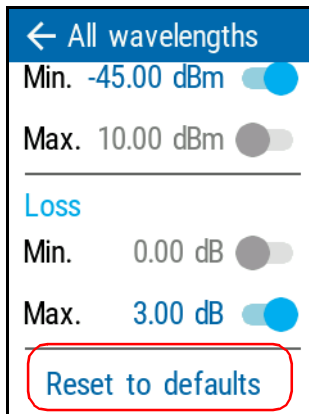



# 4 **Managing Test Results**

You can view measurements directly from your unit.

**Note:** *You cannot transfer measurements from your unit to a computer by connecting them with a USB cable.*

## **Viewing Measurements**

Every time you perform a measurement, the unit saves it using the date and time as a name. You can save up to 1000 measurements. When you reach 1001, the unit will start to overwrite the oldest measurement with the new one.

**Note:** *The unit will prompt you before overwriting old measurements.*

**To view the stored measurements:**

1. From the main window, tap **View stored**.

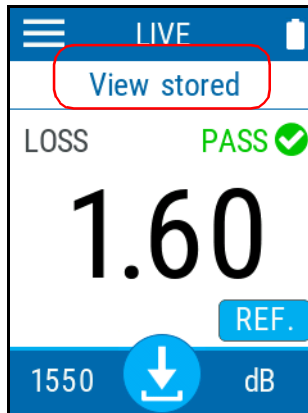

## Managing Test Results

### Viewing Measurements

---

2. Use the arrow button on each side of the page to go to the previous or next measurement.

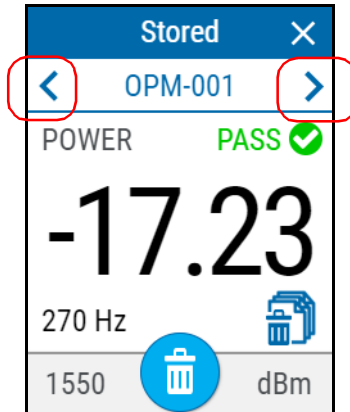





## Viewing Results in the Margin Meter

The margin meter allows you to see at a glance whether your measurement is within the threshold range that you have set.

### **To see the margin meter view:**

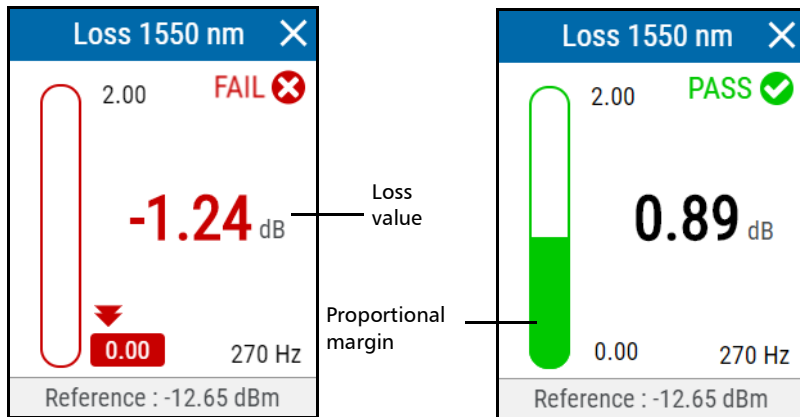
Once you have a value on-screen, simply tap on it to see the view.



Tap on  to close the view.

## Managing Test Results

### *Deleting Measurements (Clearing Data)*

---

## Deleting Measurements (Clearing Data)

To free up some disk space on your unit, you can manually delete the stored measurements. You can delete all of the measurements from the **Settings** window, or you can delete individual or all results from the stored measurement window.

**Note:** *The unit will always use the next name in sequence to store a measurement. This means that, for example, even if you delete the OPM-003 measurement right after it is complete, the unit will not reuse OPM-003 for the next measurement but will use OPM-004.*



### IMPORTANT

All of the stored measurements will be deleted, you cannot select them. Deleted measurements cannot be recovered.

#### ***To delete measurements from the Settings window:***

1. From the main PX1 page, tap the  icon to access the menu, then select .
2. Scroll down to the **Unit settings** section.

3. Tap **Reset options**.

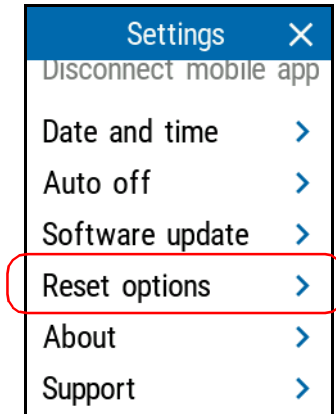

4. Select the desired option.



5. Tap **OK** to confirm your choice.

## Managing Test Results

*Deleting Measurements (Clearing Data)*

---

**To delete measurements from the stored measurements window:**

1. From the main window, tap **View stored**.

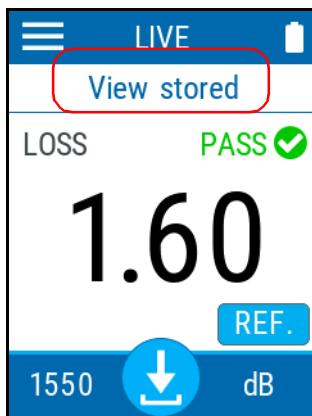

2. To remove the current measurement, tap .

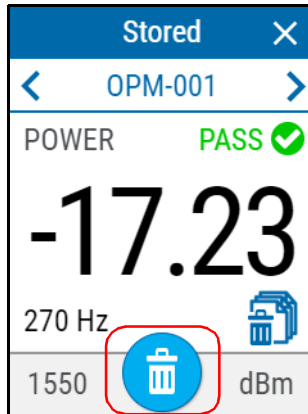

OR

- To remove all of the measurements, tap .

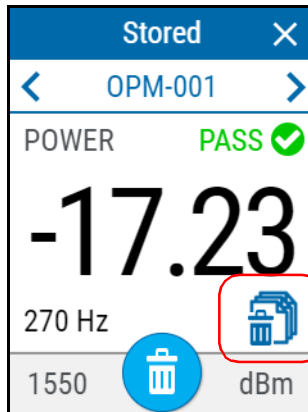

3. Confirm your choice in either case by tapping **Delete**.



# 5 Working with the TestFlow Mobile Application

You can use your PX1 in association with a smart device equipped with the EXFO TestFlow mobile application allowing you to view your results and generate reports.

**Note:** *The TestFlow mobile application gives you access to certain features even if you do not log on to your TestFlow account. However, to benefit from all the available features, you will need to log in. The procedures presented throughout this user documentation will indicate if a logon is required.*

**Note:** *Depending on the type of smart device you are using, the appearance of the Power Expert tool (available from the TestFlow mobile application) may vary slightly from the illustrations presented in this documentation. Unless otherwise specified, the information applies both to the Android- and iOS-based smart devices.*

# Installing the TestFlow Mobile Application on Your Smart Device

Before you start working, if you intend to generate reports or retrieve the firmware and software updates for your unit, you will need to install the TestFlow mobile application on your smart device.

**Note:** *For more information about TestFlow, refer to the user documentation for the application.*

### **To install the TestFlow mobile application:**

1. Ensure that you have access to an Internet connection.
2. From your Android-based smart device, open the Google Play Store (usually **Play Store** or **Play** icon).

OR

From your iOS-based smart device, open the App Store (usually **App Store** icon).

3. From the Play Store or the App Store, search for *EXFO* or *TestFlow Mobile* to localize the TestFlow mobile application.
4. Start the installation and follow the on-screen instructions.





## Establishing or Closing a Connection With a Smart Device Via the Bluetooth Technology

When you want to work with TestFlow, perform tasks such as generate reports or receive updates for your unit, interactions are necessary between the unit and a smart device equipped with the TestFlow mobile application. These interactions are accomplished using the Bluetooth<sup>®</sup> Low Energy technology. By default, the Bluetooth<sup>®</sup> communication is enabled on your unit, but if you have disabled it, you must enable it before trying to connect to a smart device .

**Note:** *To save battery power, you may wish to disable the Bluetooth<sup>®</sup> communication when you do not use it.*

On your PX1 unit, the status of the Bluetooth<sup>®</sup> communication is indicated with an icon in the title bar. The table below shows the possibilities.

Icon	Meaning
Not visible	The Bluetooth <sup>®</sup> communication is disabled.
	The Bluetooth <sup>®</sup> communication is enabled, but no connection has been established yet between the unit and a smart device.
	A connection has been established between the unit and a smart device.

If a connection has been established with a smart device already, but you wish to use your unit with another smart device, you can close the current connection directly from your unit. Similarly, if a connection exists already,



## Working with the TestFlow Mobile Application

### *Establishing or Closing a Connection With a Smart Device Via the Bluetooth Technology*

---

but you wish to connect a smart device to another PX1 unit, you can close the connection from the smart device (Power Expert tool in the TestFlow mobile application).

#### **To establish a connection via the Bluetooth® technology:**

1. If necessary, enable the Bluetooth® communication on your unit:
  - 1a. From the main PX1 page, tap the  icon to access the menu, then select .
  - 1b. Under **Unit settings**, tap **Bluetooth**.

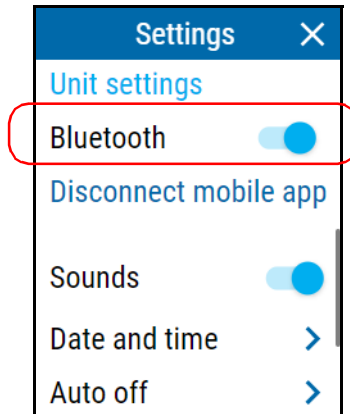

2. If it is not already done, install the TestFlow mobile application on your smart device (see *Installing the TestFlow Mobile Application on Your Smart Device* on page 64).
3. On the smart device, establish the connection as follows.
  - 3a. Open the TestFlow mobile application.
  - 3b. If the application prompts you to sign in to a TestFlow account, tap **NOT NOW**, since you do not need to connect to a TestFlow account to establish the connection between your unit and a smart device.
  - 3c. Tap the  icon to access the main menu.

## Working with the TestFlow Mobile Application

*Establishing or Closing a Connection With a Smart Device Via the Bluetooth Technology*

---

- 3d.** Under **Tools**, tap **Optical Power Meter**.
- 3e.** If the application prompts you to authorize it to access your smart phone's location, tap **ALLOW**. Otherwise, you will not be able to access the list of PX1 units.
- 3f.** From the list of PX1 units, tap the item corresponding to the desired unit.

The application establishes the communication automatically. When the connection is successful, the  icon appears in the title bar of your PX1 unit.

**Note:** *If the PX1 unit that you want to use is already connected to another smart device, you must first close the connection between the PX1 unit and the other smart device before being able to connect to this specific PX1.*

## Working with the TestFlow Mobile Application

*Establishing or Closing a Connection With a Smart Device Via the Bluetooth Technology*

### **To close the connection with a smart device from your unit:**

1. From the main PX1 page, tap the  icon to access the menu, then select .
2. Under **Unit settings**, tap **Disconnect mobile app**.

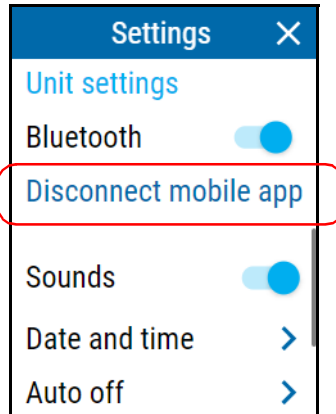

### **To close the connection with a PX1 from a smart device:**

1. From the measurements list or the measurement details page, tap the three-dot menu.

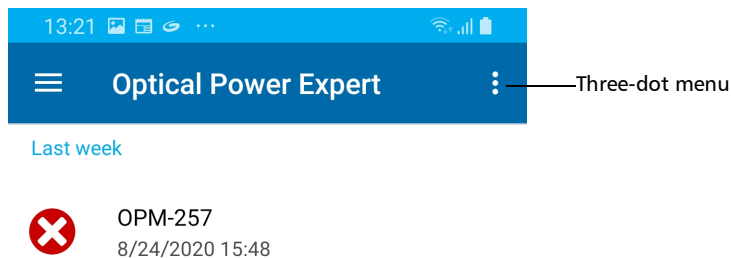

2. Tap **Disconnect**.

The smart device is no longer connected to the PX1 and you are ready to connect it to another unit.

## Generating Measurement Reports

You can generate PDF reports with the TestFlow mobile application.

Once the report has been generated, you can consult it right away with the viewer available on your smart device. Since the PDF is not saved on the smart device, you will need to generate the report again if you close it, unless you transfer it with your smart device.

It is possible to generate reports with the TestFlow mobile application.

### ***To generate job measurement reports:***

- 1.** Ensure that a Bluetooth® connection has already been established between your unit and a smart device (see *Establishing or Closing a Connection With a Smart Device Via the Bluetooth Technology* on page 65).

As soon as a connection is established between the PX1 and a smart device, the list of results in the TestFlow mobile application is refreshed automatically.

- 2.** On the smart device, if it is not already done, open the TestFlow mobile application.

## Working with the TestFlow Mobile Application

### Generating Measurement Reports

---

3. Under **Tools**, tap **Optical Power Meter**.

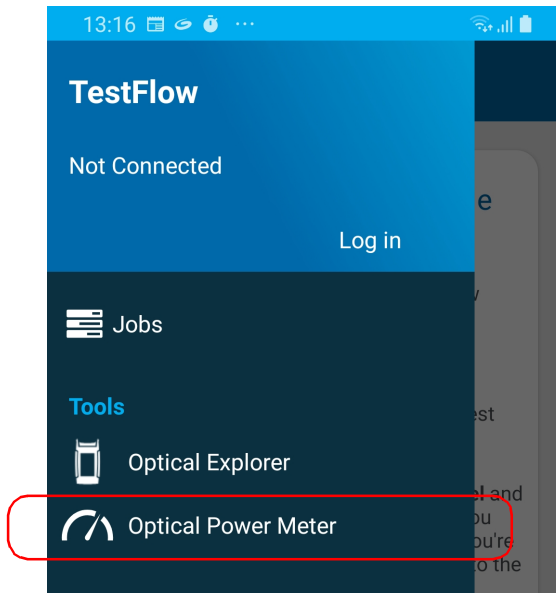

4. Select the test result for which you want to generate a report.
5. Tap the three-dot menu.

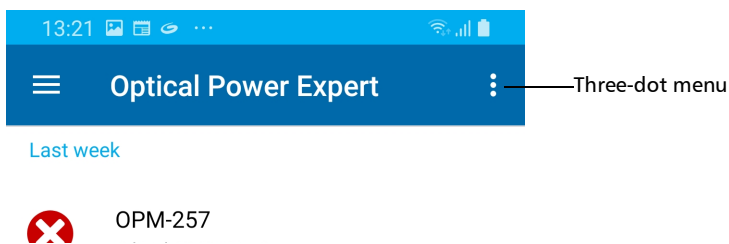

6. Select **PDF report**.

**Note:** As soon as the report is generated, you can transfer it with the tools available from your smart device as you would do with any other PDF file.

## 6 **Maintenance**

To help ensure long, trouble-free operation:

- Always inspect fiber-optic connectors before using them and clean them if necessary.
- Keep the unit free of dust.
- Clean the unit casing and front panel with a cloth slightly dampened with water.
- Store unit at room temperature in a clean and dry area. Keep the unit out of direct sunlight.
- Avoid high humidity or significant temperature fluctuations.
- Avoid unnecessary shocks and vibrations.
- If any liquids are spilled on or into the unit, turn off the power immediately, disconnect from any external power source, remove the batteries and let the unit dry completely.



### **WARNING**

The use of controls, adjustments and procedures, namely for operation and maintenance, other than those specified herein may result in hazardous radiation exposure or impair the protection provided by this unit.

## Cleaning Detector Ports

Regular cleaning of detectors will help maintain measurement accuracy.



### IMPORTANT

Always cover detectors with protective caps when unit is not in use.

#### ***To clean detector ports:***

1. Remove the protective cap and adapter (FOA) from the detector.
2. If the detector is dusty, blow dry with compressed air.
3. Being careful not to touch the soft end of the swab, moisten a cleaning tip with *only one drop* of optical-grade liquid cleaner.



### IMPORTANT

Some cleaners may leave traces if used abundantly. Do not use bottles that distribute too much liquid at a time.

4. While applying light pressure (to avoid breaking the detector window), gently rotate the cleaning tip on the detector window.
5. Repeat step 4 with a dry cleaning tip or blow dry with compressed air.
6. Discard the cleaning tips after one use.



## Cleaning VFL-Type Connectors

VFL-type connectors are fixed on your unit and can be cleaned using a mechanical cleaner.



### **WARNING**

Verifying the surface of the connector with a fiber-optic microscope **WHILE THE UNIT IS ACTIVE WILL result in permanent eye damage.**

#### ***To clean a connector using a mechanical cleaner:***

1. Insert the cleaning tip into the optical adapter, and push the outer shell into the cleaner.

**Note:** *The cleaner makes a clicking sound to indicate that the cleaning is done.*

2. Verify connector surface with a fiber inspection probe (for example, EXFO's FIP).

## Maintenance

### *Cleaning the Touchscreen*

---

## Cleaning the Touchscreen

Clean the touchscreen with a soft, non-abrasive cloth, such as one used for cleaning reading glasses, dampened with water.



### **CAUTION**

Using anything else than water can damage the special coating of the touchscreen.

## Recharging the Battery

Your unit uses one smart lithium-ion (Li-ion) or one lithium-polymer (Li-Po) battery.

- The charge status is shown in the upper right corner of the title bar. A red icon indicates that the battery level is running low and that you should connect the unit to a power outlet.
- The unit also indicates the charge status with the LED on its front panel.



### **CAUTION**

Only charge the battery with the USB cable or power adapter provided by EXFO with your unit.



## **IMPORTANT**

- The battery is not charged at the factory. You must fully charge it before using the unit for the first time. The battery is fully charged after a few hours or when the battery LED indicator is steady blue.
- The time required to charge the battery depends on various factors such as the type of tests currently performed and the ambient temperature.
- To ensure that the battery functions properly, keep it in temperatures between  $-10\text{ }^{\circ}\text{C}$  and  $45\text{ }^{\circ}\text{C}$  ( $14\text{ }^{\circ}\text{F}$  and  $113\text{ }^{\circ}\text{F}$ ). Store it between  $10\text{ }^{\circ}\text{C}$  to  $35\text{ }^{\circ}\text{C}$  ( $50\text{ }^{\circ}\text{F}$  to  $95\text{ }^{\circ}\text{F}$ ).  
When the ambient temperature is below  $0\text{ }^{\circ}\text{C}$  ( $32\text{ }^{\circ}\text{F}$ ) or when it reaches or exceeds about  $40\text{ }^{\circ}\text{C}$  ( $104^{\circ}\text{F}$ ), the battery can either charge more slowly than usual, or not charge at all, depending on the internal temperature of your unit.
- Do not leave a battery discharged for several days.
- Should you notice a decrease of the autonomy each battery charge provides, you may want to replace the battery with a new one to maintain optimal operation conditions.

## Maintenance

### Recharging the Battery

---



## IMPORTANT

- If you need to store the unit (or a battery) for an extended period of time, ensure that the battery is charged at around 50 % of its capacity, and then turn the unit off (shutdown).
- Place the unit (or the battery) in a cool dry place, and ensure that the battery is charged at around 50 % of its capacity. Every three months during the storage period, verify the battery level. Recharge the battery when necessary, so that its charge level remains around 50 % of the total capacity. This will ensure that you get the optimum performance out of the battery.

### **To recharge the battery:**

Connect the unit to a power outlet using the USB power adapter (fastest way to charge the battery).

**Note:** *The standard USB ports of a computer cannot power your unit or charge its battery while the unit is on. If you connect your unit to such a USB port with the USB cable, the unit will still consume battery power. If the unit is off when you connect it to the USB port of a computer, its battery could charge, but slowly.*

**Note:** *If you have a vehicle equipped with dedicated USB charging ports, you could connect your unit to one of these ports to charge the battery. The actual results will vary with each vehicle. You could also use a certified USB power bank (portable charger) to charge your unit.*

The charge cycle will start and end automatically.

## Battery Maintenance Recommendations



### **WARNING**

Your unit uses the following type of batteries: smart lithium-polymer (Li-Po).

These are batteries with built-in protection that have been especially designed for EXFO. For this reason, you can only replace them with EXFO-approved batteries of the same type and model.



### **WARNING**

The use of unapproved batteries may result in the batteries expanding or igniting (that is, catching fire).



### **WARNING**

Risk of explosion if battery is replaced by an incorrect type. Dispose of used batteries according to the manufacturer's instructions.



### **WARNING**

Do not throw batteries into fire or water and do not short-circuit their electrical contacts. Do not disassemble.



### **IMPORTANT**

Recycle or dispose of used batteries properly, in accordance with local regulations. Do not dispose of them in ordinary garbage receptacles. For more information, see the section about recycling and disposal in this user documentation.

## Maintenance

### *Battery Maintenance Recommendations*

---

- At EXFO, we take the safety of our customers very seriously and want to make sure any battery replacement is done properly.

The batteries of all EXFO-branded products are tested, certified, and in compliance with these international safety standards:

- United Nations (UN) Transport Regulations UN38.3: Covers battery safety during air transport.
- UL 61010-1, CAN/CSA C22.2 61010-1 and International Standard IEC/EN 61010-1: Covers the use of batteries for test and measurement equipment.
- International Standard IEC 62133: Covers secondary cells and batteries containing alkaline or other non-acid electrolytes.
- In some countries, when required, EXFO-approved batteries have been certified and are marked as per local regulation.
- To get pricing and correct part number for replacement batteries for your products, please contact (via email):
  - For Americas: [Isales.us@exfo.com](mailto:Isales.us@exfo.com)
  - For Europe: [Isales.emea@exfo.com](mailto:Isales.emea@exfo.com)
  - For APAC: [Isales.apac@exfo.com](mailto:Isales.apac@exfo.com)
  - For China: [Isales.China@exfo.com](mailto:Isales.China@exfo.com)
- You may also obtain replacement batteries for your products by contacting your local distributor:  
<https://www.exfo.com/en/how-to-buy/find-distributor>
- You may return your unit for service at your local service center:  
<https://www.exfo.com/en/services/field-network-testing/exfo-service-centers/>

## Replacing the Battery

Your unit can be powered either by battery or from an appropriate power outlet when used with the provided USB power adapter.



### WARNING

**RISK OF EXPLOSION IF BATTERY IS REPLACED BY AN INCORRECT TYPE. DISPOSE OF USED BATTERIES ACCORDING TO THE MANUFACTURER'S INSTRUCTIONS.**



### WARNING

**Do not throw batteries into fire or water and do not short-circuit their electrical contacts. Do not disassemble.**



### IMPORTANT

**Recycle or dispose of used batteries properly, in accordance with local regulations. Do not dispose of them in ordinary garbage receptacles. For more information, see the section about recycling and disposal in this user documentation.**



### WARNING

**Your unit uses a smart lithium-ion (Li-ion) or lithium-polymer (Li-Po) battery with built-in protection that has been especially designed for EXFO. For this reason, you can only replace it with batteries of the same type and model. You can purchase new batteries from EXFO.**

For more information on the available power sources for your unit, as well as their characteristics, refer to the *Technical Specifications* of your product.

## Maintenance

### *Replacing the Battery*

---



## CAUTION

Electrostatic discharge (ESD) damage can cause complete or intermittent equipment failures.

- Always use an ESD-preventive wrist or ankle strap when replacing the battery. Ensure that the antistatic strap makes good skin contact and that the end of its wire is grounded properly.
- Never touch any component inside the unit other than those identified in the procedure hereafter, either with tools or your fingers.



#### **To replace the battery:**

- 1.** Turn off the unit and disconnect the fiber and USB cable (if applicable).
- 2.** Position the unit so that its front panel rests on a flat surface such as a table.
- 3.** On the back of the unit, using a Phillips screwdriver, turn the screws (4) counterclockwise until they are loose, and remove them.

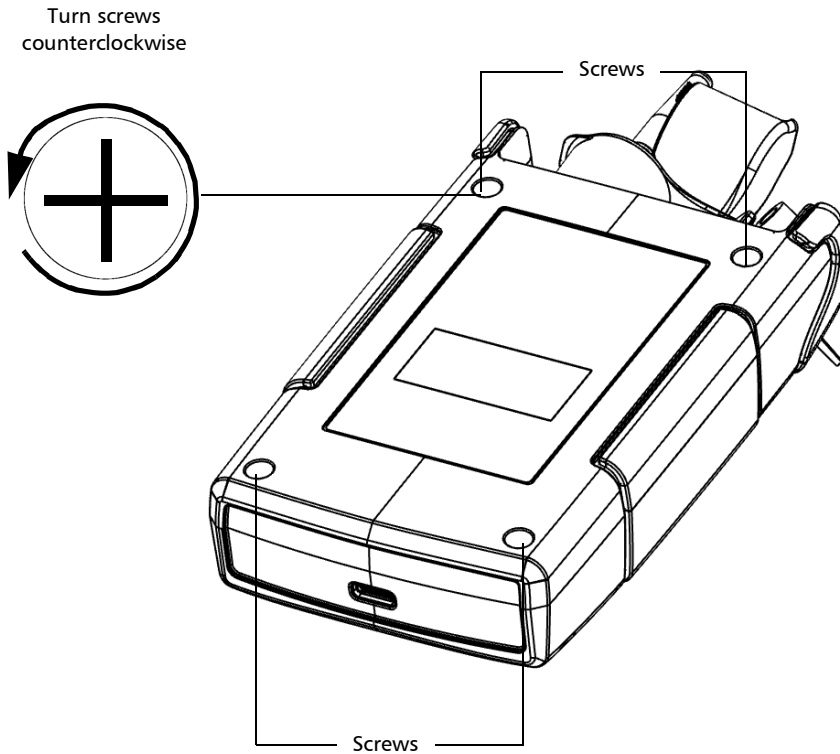

## Maintenance

### *Replacing the Battery*

---

4. Hold the back panel by its sides and pull it up to remove it.

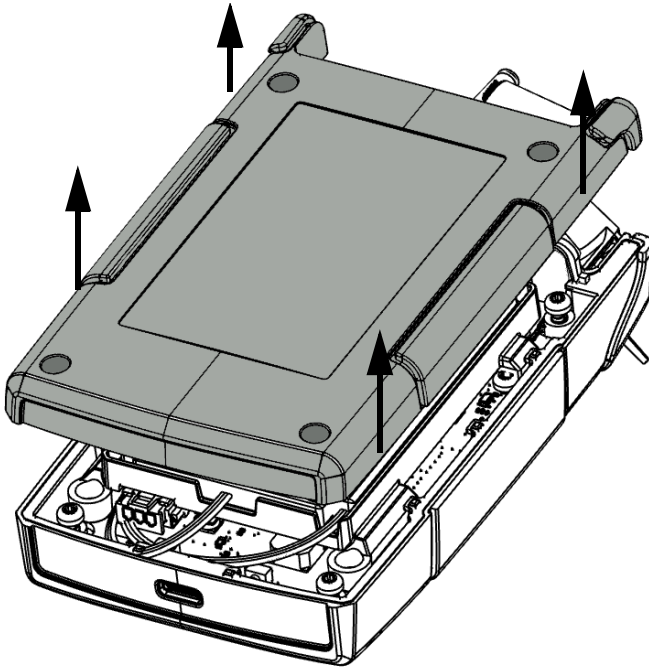

5. Gently pull on the battery's connector to disconnect it from its socket.

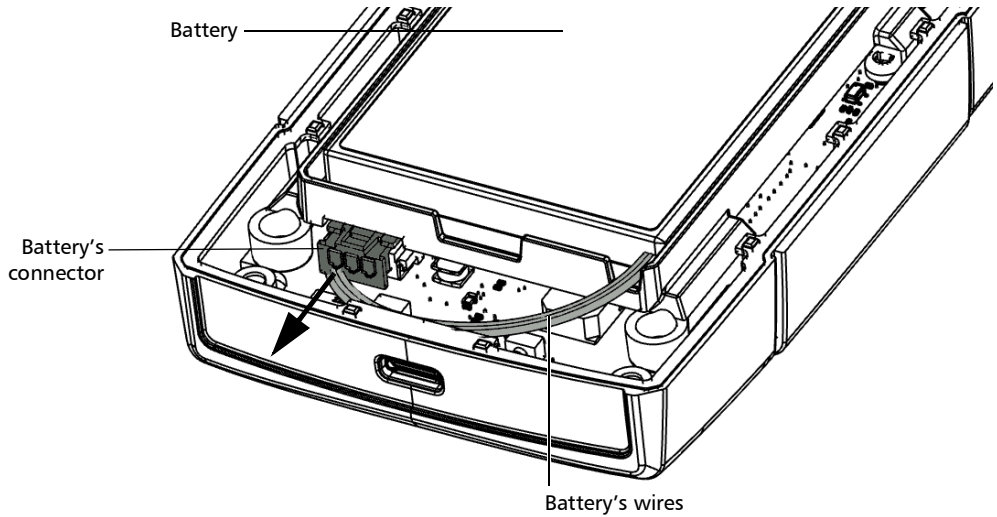

6. Pull the battery up to remove it.

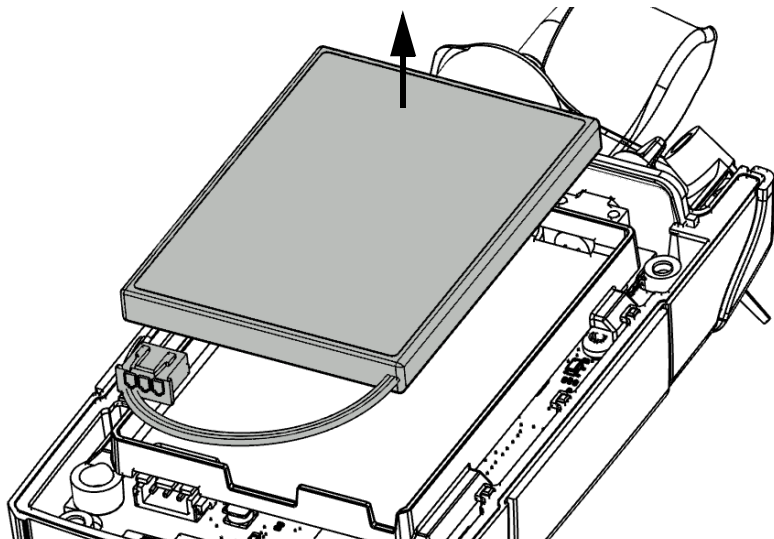

## Maintenance

### Replacing the Battery

---

7. Place the new battery so that its wires are located on the right side, toward the front.

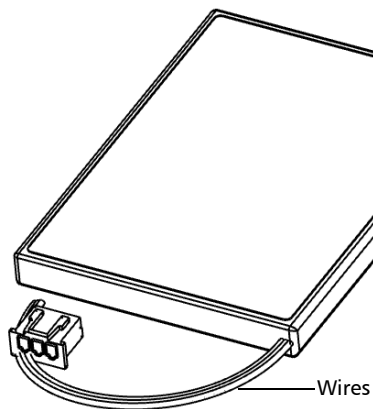

8. Place the new battery into the case.

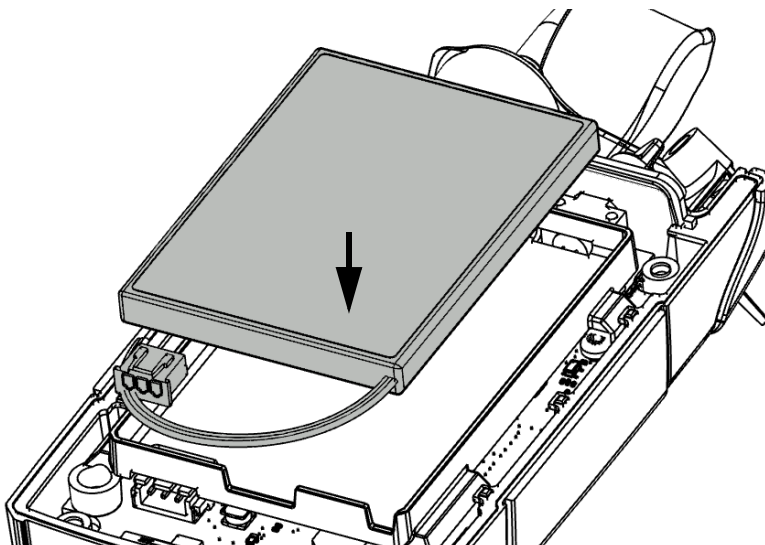

- 9.** Connect the battery's connector to the corresponding socket.

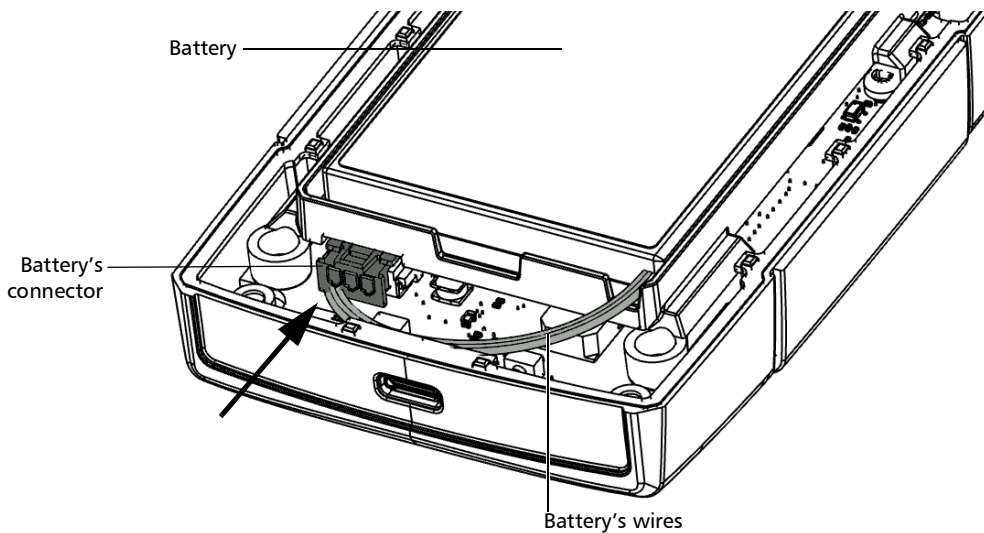

## Maintenance

### *Replacing the Battery*

---

- 10.** If the rubber gasket has moved while you replaced the battery, make sure to set it back in place, anchoring it to the small holding pins around the unit.

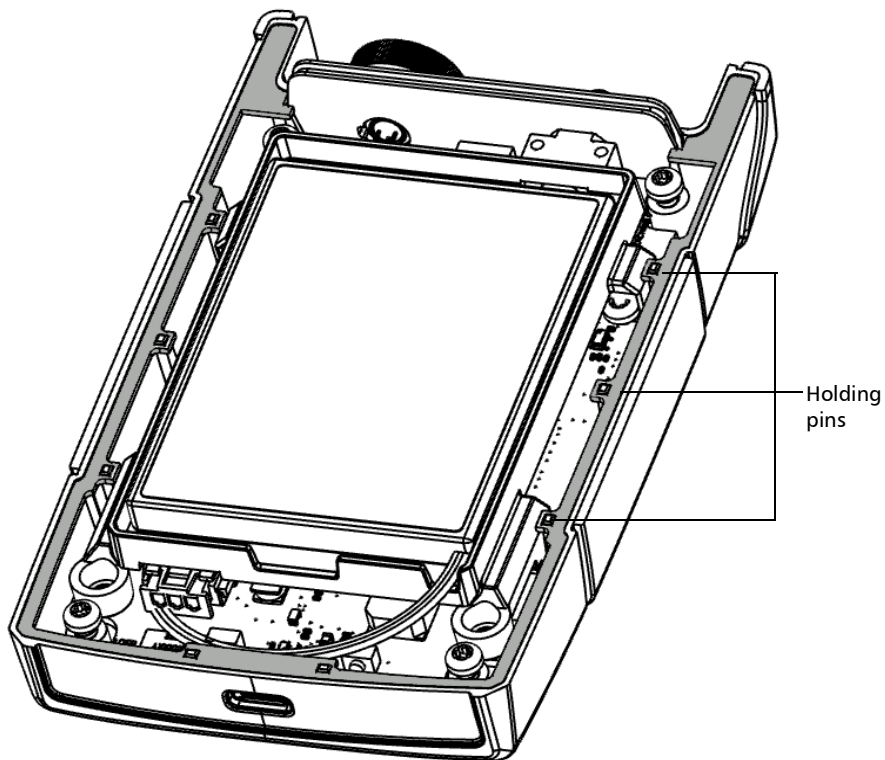

- 11.** Place the back panel on the unit, making sure that it is aligned properly with the front of the unit. The sides of the back panel should be flush with those of the front. There should be no gap between the back panel and the front of the unit. If necessary, slightly move the back panel until alignment is correct.

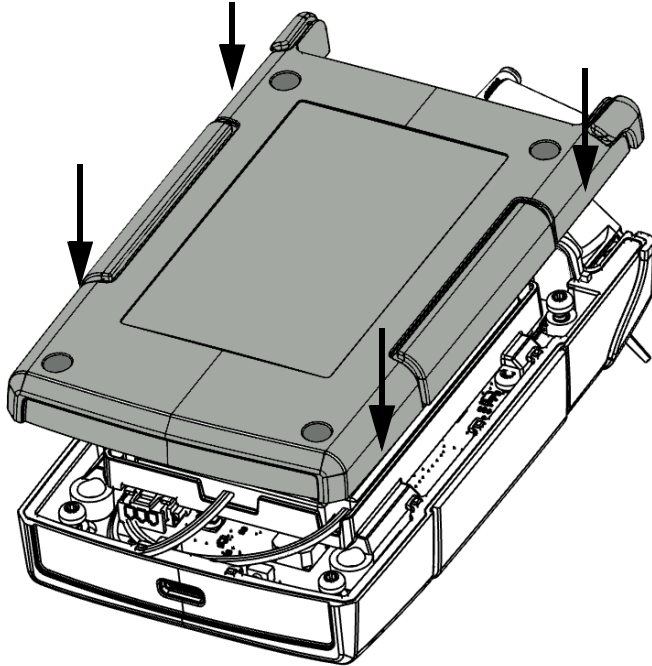

- 12.** Using a Phillips screwdriver, turn the screws (4) clockwise until they are tightened.

This will secure the back panel into place.

## Upgrading the Application

The application on your unit has been preinstalled and configured at the factory. However, you may have to upgrade it when new versions become available. Your unit allows you to check for updates, download these updates and install them directly.



**Note:** *Your unit must have access to a Bluetooth® connection to be able to download updates and install them.*



### IMPORTANT

For a trouble-free upgrade, ensure that you connect your unit to a power outlet and that your unit remains on during all the process.

#### **To upgrade the application:**

1. Connect your unit to an external power source with the provided USB power adapter.
2. If it is not already done, turn on your unit.
3. If it is not already done, download and open the TestFlow application and establish the connection to your unit. See *Installing the TestFlow Mobile Application on Your Smart Device* on page 64 and *Establishing or Closing a Connection With a Smart Device Via the Bluetooth Technology* on page 65 for details.
4. Ensure that your unit has access to Bluetooth® for the whole duration of the update.
5. From the main PX1 page, tap the  icon to access the menu, then select .



6. Under **Unit settings**, tap **Software update**.

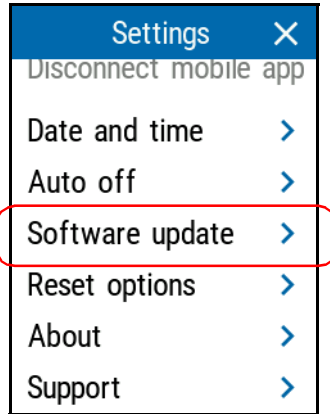

7. The unit will look for an available update. If it finds one, you can tap **Install update** to proceed with the installation.

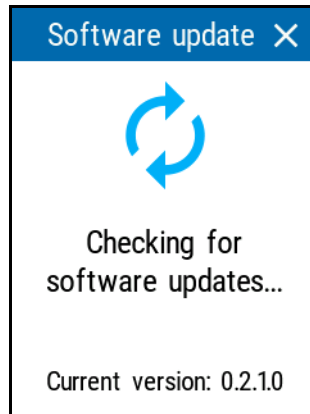

**Note:** *The update can take a few minutes to complete.*

## Recalibrating the Unit

EXFO manufacturing and service center calibrations are based on the ISO/IEC 17025 standard (*General Requirements for the Competence of Testing and Calibration Laboratories*). This standard states that calibration documents must not contain a calibration interval and that the user is responsible for determining the re-calibration date according to the actual use of the instrument.

The validity of specifications depends on operating conditions. For example, the calibration validity period can be longer or shorter depending on the intensity of use, environmental conditions and unit maintenance, as well as the specific requirements for your application. All of these elements must be taken into consideration when determining the appropriate calibration interval of this particular EXFO unit.

Under normal use, the recommended interval for your PX1 Optical Power Expert is: three years.

For newly delivered units, EXFO has determined that the storage of this product for up to six months between calibration and shipment does not affect its performance.

To help you with calibration follow-up, EXFO provides a special calibration label that complies with the ISO/IEC 17025 standard and indicates the unit calibration date and provides space to indicate the due date. Unless you have already established a specific calibration interval based on your own empirical data and requirements, EXFO would recommend that the next calibration date be established according to the following equation:

**Next calibration date = Shipping date + Recommended calibration period (three years)**

To ensure that your unit conforms to the published specifications, calibration may be carried out at an EXFO service center or, depending on the product, at one of EXFO's certified service centers. Calibrations at EXFO are performed using standards traceable to national metrology institutes.

## Recycling and Disposal



This symbol on the product means that you should recycle or dispose of your product (including electric and electronic accessories) properly, in accordance with local regulations. Do not dispose of it in ordinary garbage receptacles.

For complete recycling/disposal information, visit the EXFO Web site at [www.exfo.com/recycle](http://www.exfo.com/recycle).



# 7 Troubleshooting

## Solving Common Problems

Problem	Possible Cause	Solution
My unit does not start.	The battery is completely discharged (if the battery level allows it, the unit's LED will blink quickly to indicate the low battery status).	Connect the unit to an external power source to recharge the battery. If the battery is no longer charging properly, you may need to replace it with a new one (see <i>Replacing the Battery</i> on page 79).
My unit is not responding.	The system has encountered a problem.	Restart the unit.
The battery is not recharging.	Ambient temperature is too high or too low.	Make sure that the temperature in the location where you recharge the battery is within the specifications.
	The USB power adapter is not connected properly.	Make sure that the USB power adapter is connected to the unit and the AC outlet.  If the USB power adapter is connected properly and the problem persists, it could mean that the USB power adapter is defective. In this case, try replacing the adapter. You can purchase new USB power adapters from EXFO.
<ul style="list-style-type: none"><li>▶ I have just replaced the battery and the battery gauge is not accurate on-screen</li><li>▶ The battery level indicator does not reflect the actual charge level.</li></ul>	The recharge cycle must be reset for this new battery.	Perform a full discharge and charge cycle of the unit.

## Troubleshooting

### Accessing the Online Documentation

---

## Accessing the Online Documentation

You can also access the user guide at all times from a smart device or a computer:

- by scanning the QR code displayed on your unit
- by entering the corresponding link in a web browser

### **To access the user guide access information:**

1. From the main PX1 page, tap the  icon to access the menu, then select .
2. Under **Unit settings**, tap **Support**.

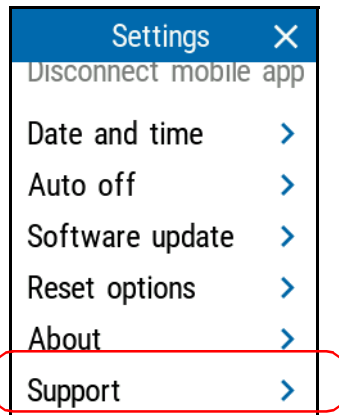

3. Scan the QR code with your smart device or enter the link on your web browser.



## **Troubleshooting**

*Contacting the Technical Support Group*

---

### **Contacting the Technical Support Group**

To obtain after-sales service or technical support for this product, contact EXFO at one of the following numbers. The Technical Support Group is available to take your calls from Monday to Friday, 8:00 a.m. to 7:00 p.m. (Eastern Time in North America).

#### **Technical Support Group**

400 Godin Avenue  
Quebec (Quebec) G1M 2K2  
CANADA

1 866 683-0155 (USA and Canada)  
Tel.: 1 418 683-5498  
Fax: 1 418 683-9224  
[support@exfo.com](mailto:support@exfo.com)

For detailed information about technical support, and for a list of other worldwide locations, visit the EXFO Web site at [www.exfo.com](http://www.exfo.com).

If you have comments or suggestions about this user documentation, you can send them to [customer.feedback.manual@exfo.com](mailto:customer.feedback.manual@exfo.com).



To accelerate the process, please have information such as the name and the serial number (see the product identification label), as well as a description of your problem, close at hand.



## Viewing System Information

You can easily access important information such as the model of your unit, the serial number, the software and hardware versions, as well as the latest hardware calibration, directly from your unit. You can also find the contact information if you ever need to reach EXFO.

**To view the system information:**

1. From the main PX1 page, tap the  icon to access the menu, then select .
2. Under **Unit settings**, tap **About**.

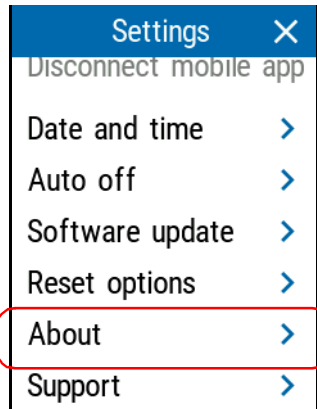

## Troubleshooting

### Viewing System Information

---

#### To retrieve the contact information:

1. From the main PX1 page, tap the  icon to access the menu, then select .
2. Under **Unit settings**, tap **Support**.

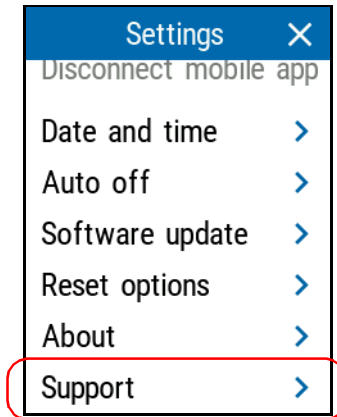

3. Scroll down the window. The information you want to view is displayed on screen.

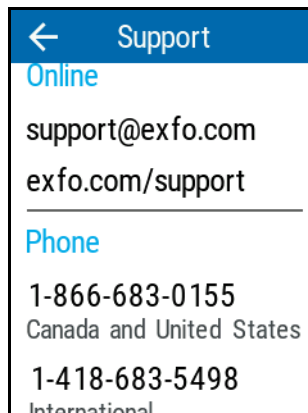

## **Transportation**

Maintain a temperature range within specifications when transporting the unit. Transportation damage can occur from improper handling. The following steps are recommended to minimize the possibility of damage:

- Pack the unit in its original packing material when shipping.
- Avoid high humidity or large temperature fluctuations.
- Keep the unit out of direct sunlight.
- Avoid unnecessary shocks and vibrations.



# 8 **Warranty**

## **General Information**

EXFO Inc. (EXFO) warrants this equipment against defects in material and workmanship for a period of one year from the date of original shipment. EXFO also warrants that this equipment will meet applicable specifications under normal use.

During the warranty period, EXFO will, at its discretion, repair, replace, or issue credit for any defective product, as well as verify and adjust the product free of charge should the equipment need to be repaired or if the original calibration is erroneous. If the equipment is sent back for verification of calibration during the warranty period and found to meet all published specifications, EXFO will charge standard calibration fees.

THIS WARRANTY IS IN LIEU OF ALL OTHER WARRANTIES EXPRESSED, IMPLIED, OR STATUTORY, INCLUDING, BUT NOT LIMITED TO, THE IMPLIED WARRANTIES OF MERCHANTABILITY AND FITNESS FOR A PARTICULAR PURPOSE. IN NO EVENT SHALL EXFO BE LIABLE FOR SPECIAL, INCIDENTAL, OR CONSEQUENTIAL DAMAGES.

## **Liability**

EXFO shall not be liable for damages resulting from the use of the product, nor shall be responsible for any failure in the performance of other items to which the product is connected or the operation of any system of which the product may be a part.

EXFO shall not be liable for damages resulting from improper usage or unauthorized modification of the product, its accompanying accessories and software.

## Warranty

### Exclusions

---

## Exclusions

EXFO reserves the right to make changes in the design or construction of any of its products at any time without incurring obligation to make any changes whatsoever on units purchased. Accessories, including but not limited to fuses, pilot lamps, batteries and universal interfaces (EUI) used with EXFO products are not covered by this warranty.

This warranty excludes failure resulting from: improper use or installation, normal wear and tear, accident, abuse, neglect, fire, water, lightning or other acts of nature, causes external to the product or other factors beyond the control of EXFO.

## Certification



### IMPORTANT

In the case of products equipped with optical connectors, EXFO will charge a fee for replacing connectors that were damaged due to misuse or bad cleaning.

EXFO certifies that this equipment met its published specifications at the time of shipment from the factory.

## Service and Repairs

EXFO commits to providing product service and repair for five years following the date of purchase.

***To send any equipment for service or repair:***

- 1.** Call one of EXFO's authorized service centers (see *EXFO Service Centers Worldwide* on page 104). Support personnel will determine if the equipment requires service, repair, or calibration.
- 2.** If equipment must be returned to EXFO or an authorized service center, support personnel will issue a Return Merchandise Authorization (RMA) number and provide an address for return.
- 3.** If possible, back up your data before sending the unit for repair.
- 4.** Pack the equipment in its original shipping material. Be sure to include a statement or report fully detailing the defect and the conditions under which it was observed.
- 5.** Return the equipment, prepaid, to the address given to you by support personnel. Be sure to write the RMA number on the shipping slip. *EXFO will refuse and return any package that does not bear an RMA number.*

**Note:** *A test setup fee will apply to any returned unit that, after test, is found to meet the applicable specifications.*

After repair, the equipment will be returned with a repair report. If the equipment is not under warranty, you will be invoiced for the cost appearing on this report. EXFO will pay return-to-customer shipping costs for equipment under warranty. Shipping insurance is at your expense.

Routine recalibration is not included in any of the warranty plans. Since calibrations/verifications are not covered by the basic or extended warranties, you may elect to purchase FlexCare Calibration/Verification Packages for a definite period of time. Contact an authorized service center (see *EXFO Service Centers Worldwide* on page 104).

## **Warranty**

*EXFO Service Centers Worldwide*

---

### **EXFO Service Centers Worldwide**

If your product requires servicing, contact your nearest authorized service center.

#### **EXFO Headquarters Service Center**

400 Godin Avenue  
Quebec (Quebec) G1M 2K2  
CANADA

1 866 683-0155 (USA and Canada)  
Tel.: 1 418 683-5498  
Fax: 1 418 683-9224  
support@exfo.com

#### **EXFO Europe Service Center**

Winchester House, School Lane  
Chandlers Ford, Hampshire S053 4DG  
ENGLAND

Tel.: +44 2380 246800  
Fax: +44 2380 246801  
support.europe@exfo.com

#### **EXFO Telecom Equipment (Shenzhen) Ltd.**

3rd Floor, Building C,  
FuNing Hi-Tech Industrial Park, No. 71-3,  
Xintian Avenue,  
Fuhai, Bao'An District,  
Shenzhen, China, 518103

Tel: +86 (755) 2955 3100  
Fax: +86 (755) 2955 3101  
support.asia@exfo.com

To view EXFO's network of partner-operated Certified Service Centers nearest you, please consult EXFO's corporate website for the complete list of service partners:

<http://www.exfo.com/support/services/instrument-services/exfo-service-centers>.



# Index

- A**
- absolute power ..... 46
  - AC requirements ..... 14, 15
  - accessing online help ..... 94
  - adapter ..... 13
  - adjusting
    - brightness..... 22
    - date and time ..... 25
  - after-sales service ..... 96
  - applications, installing ..... 88
  - auto wavelength
    - detection ..... 31
    - selection ..... 30
  - auto-switching mode ..... 31
  - available
    - models..... 3
    - wavelengths for measurement ..... 33
- B**
- backlight, setting ..... 22
  - battery
    - level ..... 74
    - maintenance recommendations ..... 74, 77
    - purchasing new ..... 78
    - recharging ..... 3, 6, 76
    - replacing or removing ..... 79, 81
    - status icons..... 5, 74
    - status LED..... 2, 4, 74
    - type allowed ..... 79
  - beep, enabling or disabling..... 23, 24
  - blinking
    - LED ..... 4
    - VFL signal ..... 49
  - Bluetooth®
    - closing connection..... 65
    - data transfer..... 65
    - establishing connection ..... 65, 66
    - frequency band data..... vii, viii
    - status ..... 65, 67
  - brightness
    - adjusting..... 22
    - icon..... 22
  - button
    - on/off..... 2, 4
    - Store ..... 2
- C**
- calibrated wavelengths..... 33
  - capacitors ..... 13
  - caution
    - of personal hazard ..... 8
    - of product hazard ..... 8
  - changing
    - battery ..... 79, 81
    - date and time ..... 25
    - measurement mode ..... 48
    - units..... 27
  - charge
    - icon..... 74
    - status of the battery ..... 74
  - charger..... 13
  - charging battery..... 3
  - cleaning
    - detector ports ..... 72
    - front panel ..... 71
    - touchscreen ..... 74
    - VFL connectors..... 73
  - closing a connection..... 65
  - configuring
    - brightness..... 22
    - date and time ..... 25
    - delay before auto off ..... 20
    - min./max. mode..... 41
    - pass/fail thresholds ..... 38

## Index

---

reference value ..... 44  
sound notifications ..... 24  
connecting via Bluetooth® ..... 65, 66  
connector cleaner ..... 73  
continuous VFL signal ..... 49  
conventions, safety ..... 8  
creating reports ..... 69  
current, electrical ..... 15  
customer service ..... 103

### D

data transfer ..... 65  
date and time, adjusting ..... 25  
dBm, units ..... 27  
default values ..... 51  
deleting measurements ..... 58  
detecting wavelength automatically ..... 31  
detector port, cleaning ..... 72  
detector port, location ..... 2, 3  
disabling sounds ..... 23, 24  
disconnecting from Bluetooth® ..... 65  
disk space, freeing ..... 58  
documentation ..... 94

### E

electrical offsets, nulling ..... 42  
enabling sounds ..... 23, 24  
equipment returns ..... 103  
establishing a connection  
via Bluetooth® ..... 65, 66  
external power supply ..... 13

### F

factory settings ..... 51  
fail status ..... 38  
favorite wavelengths ..... 33  
freeing disk space ..... 58  
frequency, Bluetooth® ..... vii, viii  
front panel, cleaning ..... 71

### G

generating reports ..... 69

### H

help, online ..... 94  
high temperature ..... 7  
hour, setting ..... 25

### I

icon  
battery status ..... 5, 74  
Bluetooth® status ..... 65, 67  
brightness ..... 22  
identification label ..... 96  
indoor use ..... 13  
input current ..... 15  
inserting battery ..... 79, 81  
insertion loss ..... 46  
installing  
software ..... 88  
TestFlow mobile application ..... 64  
internal temperature ..... 6

### L

label, identification ..... 96  
LED  
battery status ..... 2, 74  
indicators ..... 4  
Li-ion/Li-Po battery ..... 6, 79  
list of wavelengths ..... 29, 33  
loss, measuring ..... 46, 48

### M

main  
features ..... 1  
window ..... 19  
maintenance  
battery ..... 74, 77  
detector ports ..... 72



# Index

---

setting	
brightness.....	22
date and time.....	25
min./max. mode.....	41
pass/fail thresholds.....	38
reference value.....	44
reset.....	51
software update.....	88
sound notifications.....	24
shipping to EXFO.....	103
shutting down.....	18
software, installing and upgrading.....	88
sound notifications.....	23, 24
specifications, product.....	7
status, Bluetooth®.....	65, 67
storage requirements.....	71
storage space, managing.....	58
Store button.....	2
switching wavelengths.....	31
symbols, safety.....	8
<b>T</b>	
taking a reference value.....	44
technical specifications.....	7
technical support.....	96
temperature for storage.....	71
temperature management.....	7
temperature, internal.....	6
TestFlow mobile application, installation....	64
thresholds, viewing.....	57
touchscreen	
cleaning.....	74
location.....	2
transferring data via Bluetooth®.....	65
transportation requirements.....	71, 99
turning off unit.....	17, 18
turning on	
unit.....	17, 18
VFL.....	49
turning on/off sounds.....	23, 24

## U

understanding main window.....	19
unit	
repairing.....	13
unexpected shutdown.....	7
ventilation.....	14
units, changing.....	27
updating applications.....	88
USB	
port.....	3
power adapter.....	6, 76
power bank.....	6, 76
user guides.....	94

## V

ventilation.....	14
VFL	
cleaning.....	73
location.....	2, 3
using.....	49
view, margin meter.....	57
viewing measurements.....	55

## W

warranty	
certification.....	102
exclusions.....	102
general.....	101
liability.....	101
watts, units.....	27
wavelengths	
automatic.....	30
changing.....	29
detecting automatically.....	31
favorites.....	33

CHINESE REGULATION ON RESTRICTION OF HAZARDOUS SUBSTANCES (RoHS)  
中国关于有害物质限制的规定

NAMES AND CONTENTS OF THE TOXIC OR HAZARDOUS SUBSTANCES OR ELEMENTS  
CONTAINED IN THIS EXFO PRODUCT  
包含在本 EXFO 产品中的有毒有害物质或元素的名称及含量

Part Name 部件名称	Lead 铅 (Pb)	Mercury 汞 (Hg)	Cadmium 镉 (Cd)	Hexavalent Chromium 六价铬 (Cr(VI))	Polybrominated biphenyls 多溴联苯 (PBB)	Polybrominated diphenyl ethers 多溴二苯醚 (PBDE)
Enclosure 外壳	O	O	O	O	O	O
Electronic and electrical sub-assembly 电子和电气组件	X	O	X	O	X	X
Optical sub-assembly <sup>a</sup> 光学组件 <sup>a</sup>	X	O	O	O	O	O
Mechanical sub-assembly <sup>a</sup> 机械组件 <sup>a</sup>	O	O	O	O	O	O

Note:

注:

This table is prepared in accordance with the provisions of SJ/T 11364.

本表依据 SJ/T 11364 的规定编制。

O: Indicates that said hazardous substance contained in all of the homogeneous materials for this part is below the limit requirement of GB/T 26572.

O: 表示该有害物质在该部件所有均质材料中的含量均在 GB/T 26572 标准规定的限量要求以下。

X: indicates that said hazardous substance contained in at least one of the homogeneous materials used for this part is above the limit requirement of GB/T 26572. Due to the limitations in current technologies, parts with the "X" mark cannot eliminate hazardous substances.

X: 表示该有害物质至少在该部件的某一均质材料中的含量超出 GB/T 26572 标准规定的限量要求。



标记 "X" 的部件, 皆因全球技术发展水平限制而无法实现有害物质的替代。

a. If applicable.

如果适用。

MARKING REQUIREMENTS

标注要求

Product 产品	Environmental protection use period (years) 环境保护使用期限 (年)	Logo 标志
This EXFO product 本 EXFO 产品	10	
Battery <sup>a</sup> 电池	5	

a. If applicable.  
如果适用。

P/N: 1080228

[www.EXFO.com](http://www.EXFO.com) · [info@EXFO.com](mailto:info@EXFO.com)

**CORPORATE HEADQUARTERS** 400 Godin Avenue

Quebec (Quebec) G1M 2K2 CANADA  
Tel.: 1 418 683-0211 · Fax: 1 418 683-2170

**TOLL-FREE** (USA and Canada)

1 800 663-3936

© 2020 EXFO Inc. All rights reserved.  
Printed in Canada (2020-09)

